

**Product Specification**

	Model: GKVGC1MNDK2A0	Rev. No.	Issued Date.	Page.
		C	2014/DEC/09	1 / 18

Thin-Film-Transistor LCD Module  
Model: GKVGC1MNDK2A0

Acceptance

**Solomon Goldentek Display Corp.**  
**NO. 18 Ta-Yeh St., Ta-Fa Industrial Park, Ta-Liao**  
**Hsiang, Kaohsiung Hsien 831, TAIWAN , R.O.C.**  
FAX: 886-7-7886800

Approved and Checked by

Approved by	Checked by		Made by
			

**Product Specification**

	Model: GKVGC1MNDK2A0	Rev. No.	Issued Date.	Page.
		C	2014/DEC/09	2 / 18

Revise Records

Rev.	Date	Contents	Written	Approved
A	2013/11/07	Preliminary Specification	Carl Lin	Roger Yang
B	2013/11/22	Update 4. Optical Characteristics LED Life Time	Carl Lin	Roger Yang
C	2014/12/09	Modify 8. Dimensional Outlines	Carl Lin	Roger Yang

Special Notes

Note1.	
Note2.	
Note3.	
Note4.	
Note5.	

Product Specification				
	Model: GKVGC1MNDK2A0	Rev. No.	Issued Date.	Page.
		C	2014/DEC/09	3 / 18

## Contents

<b>1. General Description and Features</b>	4
1.1 Features	4
1.2 LCD Module	4
<b>2. Mechanical Information</b>	4
<b>3. Electrical Specifications</b>	5
3.1 Absolute Max. Ratings	5
3.2 AC Timing Characteristic of The LCD	6
3.3 Back-Light Unit	8
<b>4. Optical Characteristics</b>	9
4.1 Optical characteristic of the LCD	9
<b>5. I/O Terminal</b>	12
5.1 Pin Assignment (CN1 P/N: Starconn 093G30-B0001A-G4 or equivalent.)	12
5.2 Back Light Unit (CN2 P/N: 35001HS-02L or equivalent.)	13
5.3 Block Diagram	14
<b>6. Displayed Color and Input Data</b>	15
<b>7. Reliability Condition</b>	16
<b>8. Dimensional Outlines</b>	17

## Product Specification

	Model: GKVGC1MNDK2A0	Rev. No.	Issued Date.	Page.
		C	2014/DEC/09	4 / 18

### 1. General Description and Features

GKVGC1MNDK2A0 is a transmissive type color active matrix TFT (Thin Film Transistor) liquid crystal display (LCD) that uses amorphous silicon TFT as a switching device. This model is composed of a TFT-LCD module, a driver circuit and a back-light unit. Graphics and texts can be displayed on a WXGA 1280 (W) x RGB x 800 (H) dots (16:10 aspect ratio) with 262,144 colors by supplying 18 bits data signal (6bits/each color). The following table described the features of GKVGC1MNDK2A0.

#### 1.1 Features

- Transmissive and back-light with 80 LEDs are available.
- TN (Twisted Nematic) mode.
- LVDS 6/8 bits.
- Data enable mode.
- RoHS Compliance
- MVA
- IIS: T1210NN01

#### 1.2 LCD Module

Item	Specification	Unit
Screen Size	12.1 inches	Diagonal
Display Resolution	1280 (H) x 800 (V)	Pixel
Active Area	261.12(H) x 163.2(V)	mm
Outline Dimension	278(H) x 184(V) x 7 (T)	mm
Display Mode	Normally Black/Transmissive	--
Pixel Arrangement	R,G,B Vertical Stripe	--
Pixel Size	0.204(H) x 0.204(V)	mm
Surface Treatment	AG, 3H Hard Coating	
Display Color	262K/16.2M	--
Input Interface	LVDS 6/8 bit Interface	--

### 2. Mechanical Information

Item	Min.	Typ.	Max.	Unit	Note	
Module Size	Horizontal (H)	-	(278)	-	mm	
	Vertical (V)	-	(184)	-	mm	
	Thickness (T)	-	(7)	-	mm	(1)
Weight		(555)		g	--	

Note (1) Not Include Component. Refer to the Outline Dimension Drawing as attached.

## Product Specification

	Model: GKVGC1MNDK2A0	Rev. No.	Issued Date.	Page.
		C	2014/DEC/09	5 / 18

### 3. Electrical Specifications

#### 3.1 Absolute Max. Ratings

##### 3.1.1 Absolute Ratings of Environment

If the operating condition exceeds the following absolute maximum ratings, the TFT LCD module may be damaged permanently.

(Ta=25±2°C, V<sub>SS</sub>=GND=0)

Item	Symbol	Min.	Max.	Unit	Note
Storage temperature	T <sub>STG</sub>	-30	80	°C	(1)
Operating temperature	T <sub>OPR</sub>	-20	70	°C	(1,2,3)

Note (1) 90 % RH Max. ( 40 °C ≥ Ta ). Maximum wet-bulb temperature at 39 °C or less. (Ta > 40 °C) No condensation.

Note (2) In case of below 0°, the response time of liquid crystal (LC) becomes slower and the color of panel becomes darker than normal one. Level of retardation depends on temperature, because of LC's character

Note (3) Only operation is guaranteed at operating temperature. Contrast, response time, another display quality are evaluated at +25°C.

##### 3.1.2 Electrical Absolute Maximum Ratings

###### 3.1.2.1 TFT-LCD Module

(V<sub>SS</sub>=GND=0)

Parameter	Symbol	Min.	Max.	Unit	Remark
Power supply voltage	V <sub>CC</sub>	-0.3	4.0	V	
Logic Input Voltage	V <sub>IN</sub>	-0.3	V <sub>CC</sub> +0.3	V	

###### 3.1.2.2 Backlight Unit

(V<sub>SS</sub>=GND=0)

Parameter	Symbol	Min.	Max.	Unit	Remark
Current of Backlight Unit	IB	--	(600)	mA	
Voltage of Backlight Unit	VB	--	(31.2)	V	

## Product Specification

	Model: GKVGC1MNDK2A0	Rev. No.	Issued Date.	Page.
		C	2014/DEC/09	6 / 18

### 3.1.3 DC Electrical Characteristics of the TFT LCD

(Ta=25±2°C, V<sub>SS</sub>=GND=0)

Item	Symbol	Min.	Typ.	Max.	Unit	Remark
Power supply	VCC	3.0	3.3	3.6	V	
LVDS Differential Input High Threshold	V <sub>TH(LVDS)</sub>	-	-	+100	mv	
LVDS Differential Input Low Threshold	V <sub>TL(LVDS)</sub>	-100	-	-	mv	
Power Supply current	ICC	(350)	(385)	(420)	mA	Note 1

Note1: f<sub>v</sub> =60Hz , Ta=25°C , Display pattern : Black pattern



### 3.2 AC Timing Characteristic of The LCD

#### 3.2.1 Timing Condition (DE only mode)

Signal	Parameter	Symbol	Min.	Typ.	Max.	Unit.	Remark
DCLK	CLK frequency	1/T <sub>C</sub>	67.45	71	74.55	MHz	
DE	Vertical Total Time	TV	810	823	1000	TH	
	Vertical Addressing Time	TVD	800	800	800	TH	
	Horizontal Total Time	TH	1360	1440	1600	T <sub>C</sub>	
	Horizontal Addressing Time	THD	1280	1280	1280	T <sub>C</sub>	

# Product Specification



Model: GKVGC1MNDK2A0

Rev. No.

Issued Date.

Page.

C

2014/DEC/09

7 / 18

## 3.2.2 Timing Characteristic

### 3.2.2.1 DE and Data Input Timing

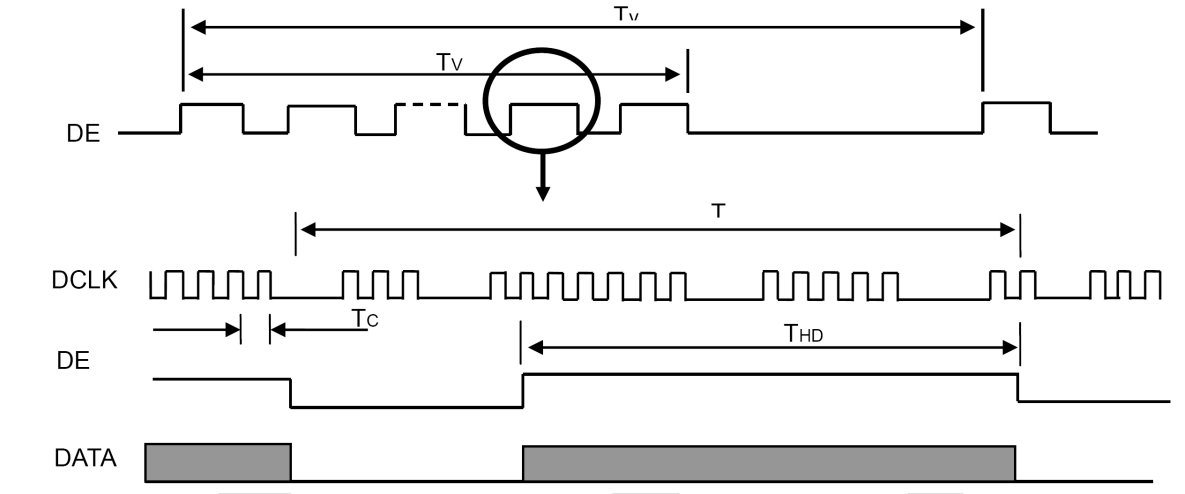

## Product Specification

	Model: GKVGC1MNDK2A0	Rev. No.	Issued Date.	Page.
		C	2014/DEC/09	8 / 18

### 3.3 Back-Light Unit

The Back-light system is an edge-lighting type with 80 white LED (Light Emitting Diode)s. The characteristics of 80 white LEDs are shown in the following tables.

(Ta= Room Temp)

Characteristics	Symbol	Min.	Typ.	Max.	Unit	Note
Forward Voltage	VB	(22.4)	-	(31.2)	V	
Forward Current	IB	-	(500)	-	mA	(1)
Power Consumption	P <sub>BL</sub>	-	(TBD)	-	mW	

Note (1) LEDs in 8 series x 5 parallel x 2 type.

(2) The environmental conducted under ambient air flow ,at Ta=25±2°C, 60%RH±5%



## Product Specification

	Model: GKVGC1MNDK2A0	Rev. No.	Issued Date.	Page.
		C	2014/DEC/09	9 / 18

### 4. Optical Characteristics

#### 4.1 Optical characteristic of the LCD

The following items are measured under stable conditions. The optical characteristics should be measured in a dark room or equivalent state with the methods.

Measuring equipment: BM-7A

Item	Symbol	Condition	Min.	Typ.	Max.	Unit	Note	
Brightness	B		(1000)	(1300)	-	cd/m <sup>2</sup>		
Response time	T <sub>r</sub>	θ=0°	-	15	20	ms		
	T <sub>f</sub>		-	10	15	ms		
Contrast ratio	CR	At optimized viewing angle	800	1000	-	--		
Luminance Uniformity	ΔL		75	-	-	%		
Color Chromaticity (CIE 1931)	White	θ=0° Normal Viewing Angle	W <sub>x</sub>	(TBD)	(TBD)	(TBD)	--	BM-7A
			W <sub>y</sub>	(TBD)	(TBD)	(TBD)		
Viewing Angle	Hor.	CR≥10	θ <sub>R</sub>	80	88	-	Degree	
			θ <sub>L</sub>	80	88	-		
	Ver.		θ <sub>U</sub>	80	88	-		
			θ <sub>D</sub>	80	88	-		
LED Life Time	-	-	(30000)	-	-	hrs		

## Product Specification

	Model: GKVGC1MNDK2A0	Rev. No.	Issued Date.	Page.
		C	2014/DEC/09	10 / 18

a. Test equipment setup

After stabilizing and leaving the panel alone shall be warmed up for the stable operation of LCM, the measurement should be executed. Measurement should be executed in a stable, windless, and dark room. Optical specifications are measured by Topcon BM-7(fast) with a viewing angle of 2° at a distance of 50cm and normal direction.

b. Definition of response time: Tr and Tf

The response time is defined as the following figure and shall be measured by switching the input signal for "black" and "white".

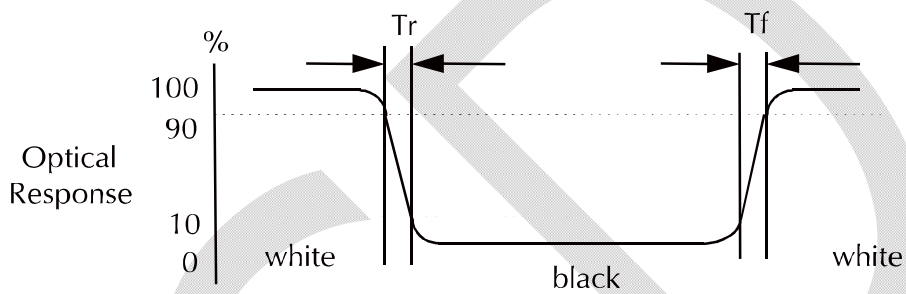

c. Definition of contrast ratio:

$$\text{Contrast Ratio (CR)} = \frac{\text{Brightness measured when LCD is at "white state"}}{\text{Brightness measured when LCD is at "black state"}}$$

d. Measured at the center area of the panel when all the input terminals of LCD panel are electrically opened.

## Product Specification

	Model: GKVGC1MNDK2A0	Rev. No.	Issued Date.	Page.
		C	2014/DEC/09	11 / 18

e. View Angle

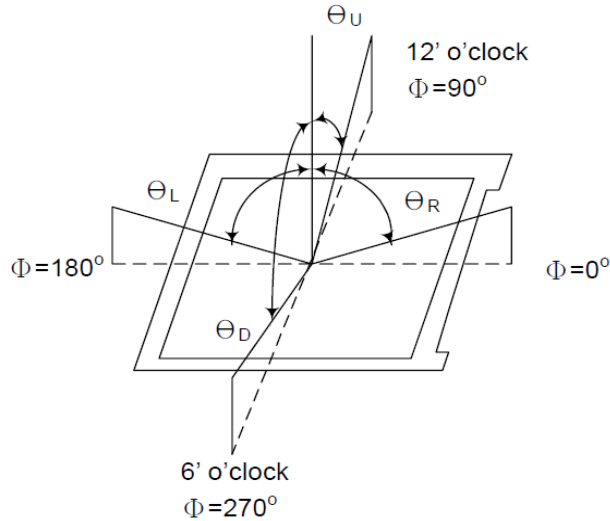

f. Definition of Luminance of White: Luminance of white at the center points

Light Source of Back-Light Unit	LED Type
---------------------------------	----------

g. Definition of White Uniformity

$$\text{White Uniformity} = \frac{\text{Min. luminance of white among 9-points}}{\text{Max. luminance of white among 9-points}} \times 100\%$$

h. The definition of Color Gamut -Color Chromaticity CIE 1931

Color coordinate of white & red, green, blue at center point.

Color Gamut : NTSC(%) = ( RGB Triangle Area / NTSC Triangle Area ) x 100

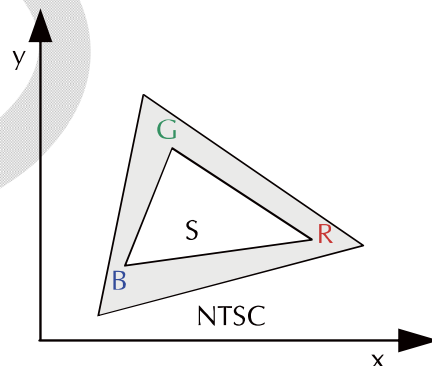

## Product Specification

	Model: GKVGC1MNDK2A0	Rev. No.	Issued Date.	Page.
		C	2014/DEC/09	12 / 18

### 5. I/O Terminal

5.1 Pin Assignment (CN1 P/N: Starconn 093G30-B0001A-G4 or equivalent.)

Pin No.	Symbol	I/O	Function	Remark
1	NC	-	NO Connect	
2	NC	-	NO Connect	
3	NC	-	NO Connect	
4	NC	-	NO Connect	
5	NC	-	NO Connect	
6	NC	-	NO Connect	
7	GND	P	Ground	
8	GND	P	Ground	
9	VCC	P	Power Supply +3.3V	
10	VCC	P	Power Supply +3.3V	
11	GND	P	Ground	
12	GND	P	Ground	
13	RX0-	I	Negative LVDS differential data 0 input	
14	RX0+	I	Positive LVDS differential data 0 input	
15	GND	P	Ground	
16	RX1-	I	Negative LVDS differential data 1 input	
17	RX1+	I	Positive LVDS differential data 1 input	
18	GND	P	Ground	
19	RX2-	I	Negative LVDS differential data 2 input	
20	RX2+	I	Positive LVDS differential data 2 input	
21	GND	P	Ground	
22	RXCLK-	I	Negative LVDS differential clock input	
23	RXCLK+	I	Positive LVDS differential clock input	
24	GND	P	Ground	
25	RX3-	I	Negative LVDS differential data 3 input	
26	RX3+	I	Positive LVDS differential data 3 input	
27	GND	P	Ground	
28	SEL6/8	I	LVDS 6/8 bit select function control, Low or NC : 6bit input mode High : 8bit input mode	
29	GND	P	Ground	
30	GND	P	Ground	

## Product Specification

	Model: GKVGC1MNDK2A0	Rev. No.	Issued Date.	Page.
		C	2014/DEC/09	13 / 18

I: Input, P: Power

Notes:

- 1) NC Pin must be retained; this pin can't contact VSS or other signal.
- 2) VSS Pin must ground contact, can not be floating.

### 5.2 Back Light Unit (CN2 P/N: 35001HS-02L or equivalent.)

Pin No.	Symbol	Function	Remark
1	LEDA	Power Supply for LED backlight	RED
2	LEDK	GND for LED backlight	BLACK

# Product Specification



Model: GKVGC1MNDK2A0

Rev. No.

Issued Date.

Page.

C

2014/DEC/09

14 / 18

## 5.3 Block Diagram

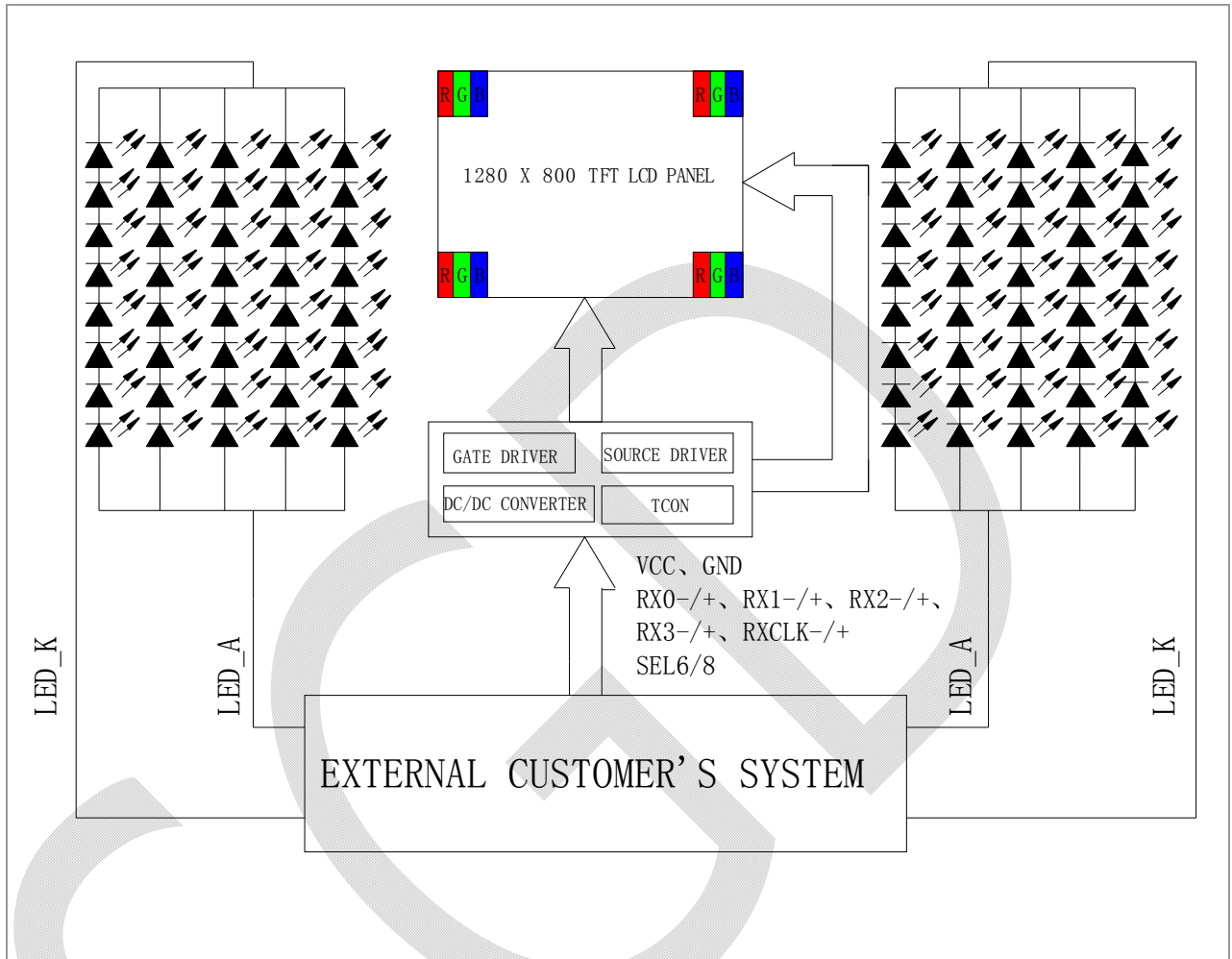

## Product Specification

	Model: GKVGC1MNDK2A0	Rev. No.	Issued Date.	Page.
		C	2014/DEC/09	15 / 18

### 6. Displayed Color and Input Data

	Color & Gray Scale	Data Signal																	
		R5	R4	R3	R2	R1	R0	G5	G4	G3	G2	G1	G0	B5	B4	B3	B2	B1	B0
Basic Color	Black	0	0	0	0	0	0	0	0	0	0	0	0	0	0	0	0	0	0
	Red(0)	1	1	1	1	1	1	0	0	0	0	0	0	0	0	0	0	0	0
	Green(0)	0	0	0	0	0	0	1	1	1	1	1	1	0	0	0	0	0	0
	Blue(0)	0	0	0	0	0	0	0	0	0	0	0	0	1	1	1	1	1	1
	Cyan	0	0	0	0	0	0	1	1	1	1	1	1	1	1	1	1	1	1
	Magenta	1	1	1	1	1	1	0	0	0	0	0	0	1	1	1	1	1	1
	Yellow	1	1	1	1	1	1	1	1	1	1	1	1	0	0	0	0	0	0
	White	1	1	1	1	1	1	1	1	1	1	1	1	1	1	1	1	1	1
Red	Black	0	0	0	0	0	0	0	0	0	0	0	0	0	0	0	0	0	0
	Red(62)	0	0	0	0	0	1	0	0	0	0	0	0	0	0	0	0	0	0
	Red(61)	0	0	0	0	1	0	0	0	0	0	0	0	0	0	0	0	0	0
	:	:	:	:	:	:	:	:	:	:	:	:	:	:	:	:	:	:	:
	Red(31)	0	1	1	1	1	1	0	0	0	0	0	0	0	0	0	0	0	0
	:	:	:	:	:	:	:	:	:	:	:	:	:	:	:	:	:	:	:
	Red(1)	1	1	1	1	1	0	0	0	0	0	0	0	0	0	0	0	0	0
	Red(0)	1	1	1	1	1	1	0	0	0	0	0	0	0	0	0	0	0	0
Green	Black	0	0	0	0	0	0	0	0	0	0	0	0	0	0	0	0	0	0
	Green(62)	0	0	0	0	0	0	0	0	0	0	0	1	0	0	0	0	0	0
	Green(61)	0	0	0	0	0	0	0	0	0	0	1	0	0	0	0	0	0	0
	:	:	:	:	:	:	:	:	:	:	:	:	:	:	:	:	:	:	:
	Green(31)	0	0	0	0	0	0	0	1	1	1	1	0	0	0	0	0	0	0
	:	:	:	:	:	:	:	:	:	:	:	:	:	:	:	:	:	:	:
	Green(1)	0	0	0	0	0	0	1	1	1	1	1	0	0	0	0	0	0	0
	Green(0)	0	0	0	0	0	0	1	1	1	1	1	1	0	0	0	0	0	0
Blue	Black	0	0	0	0	0	0	0	0	0	0	0	0	0	0	0	0	0	0
	Blue(62)	0	0	0	0	0	0	0	0	0	0	0	0	0	0	0	0	0	1
	Blue(61)	0	0	0	0	0	0	0	0	0	0	0	0	0	0	0	0	1	0
	:	:	:	:	:	:	:	:	:	:	:	:	:	:	:	:	:	:	:
	Blue(31)	0	0	0	0	0	0	0	0	0	0	0	0	0	1	1	1	1	1
	:	:	:	:	:	:	:	:	:	:	:	:	:	:	:	:	:	:	:
	Blue(1)	0	0	0	0	0	0	0	0	0	0	0	0	1	1	1	1	1	0
	Blue(0)	0	0	0	0	0	0	0	0	0	0	0	0	1	1	1	1	1	1

0 : Low level voltage, 1 :High level voltage

Each basic color can be displayed in 64 gray scales from 6 bit data signals. With the combination of total 18 bit data signals, the 262,144-color display can be achieved on the screen.

## Product Specification

	Model: GKVGC1MNDK2A0	Rev. No.	Issued Date.	Page.
		C	2014/DEC/09	16 / 18

### 7. Reliability Condition

No change on display and in operation under the following test condition.

Condition: Unless otherwise specified, tests will be conducted under the following condition.

Temperature:  $20 \pm 5^\circ\text{C}$ .

Humidity:  $65 \pm 5\% \text{RH}$ .

Tests will be not conducted under functioning state.

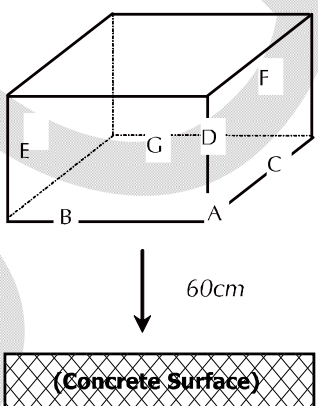
No.	Parameter	Condition	Notes
1	High Temperature Operating	$70^\circ\text{C} \pm 2^\circ\text{C}$ , 240hrs (Operation state).	
2	Low Temperature Operating	$-20^\circ\text{C} \pm 2^\circ\text{C}$ , 240hrs (Operation state).	1
3	High Temperature Storage	$80^\circ\text{C} \pm 2^\circ\text{C}$ , 240hrs.	2
4	Low Temperature Storage	$-30^\circ\text{C} \pm 2^\circ\text{C}$ , 240hrs.	1,2
5	High Temperature and High Humidity Operation Test	$60^\circ\text{C} \pm 2^\circ\text{C}$ , 90%, 240hrs.	1,2
6	Vibration Test	Total fixed amplitude: 3.5mm. Vibration Frequency: 9~500Hz. One cycle 60 seconds to 3 direction of X, Y, Z each 15 minutes.	3
7.	Drop Test	To be measured after dropping from 60cm high on the concrete surface in packing state.   <p style="margin-left: 200px;"><i>Dropping method corner dropping:</i></p> <p style="margin-left: 200px;"><i>A corner: Once edge dropping.</i></p> <p style="margin-left: 200px;"><i>B, C, D edge: Once face dropping.</i></p> <p style="margin-left: 200px;"><i>E, F, G face: Once.</i></p>	

- Notes:
1. No dew condensation to be observed.
  2. The function test shall be conducted after 4 hours storage at the normal temperature and humidity after removed from the test chamber.
  3. Vibration test will be conducted to the product itself without putting I in a container.



## Product Specification



Model: GKVGC1MNDK2A0

Rev. No.

Issued Date.

Page.

C

2014/DEC/09

17 / 18

### 8. Dimensional Outlines

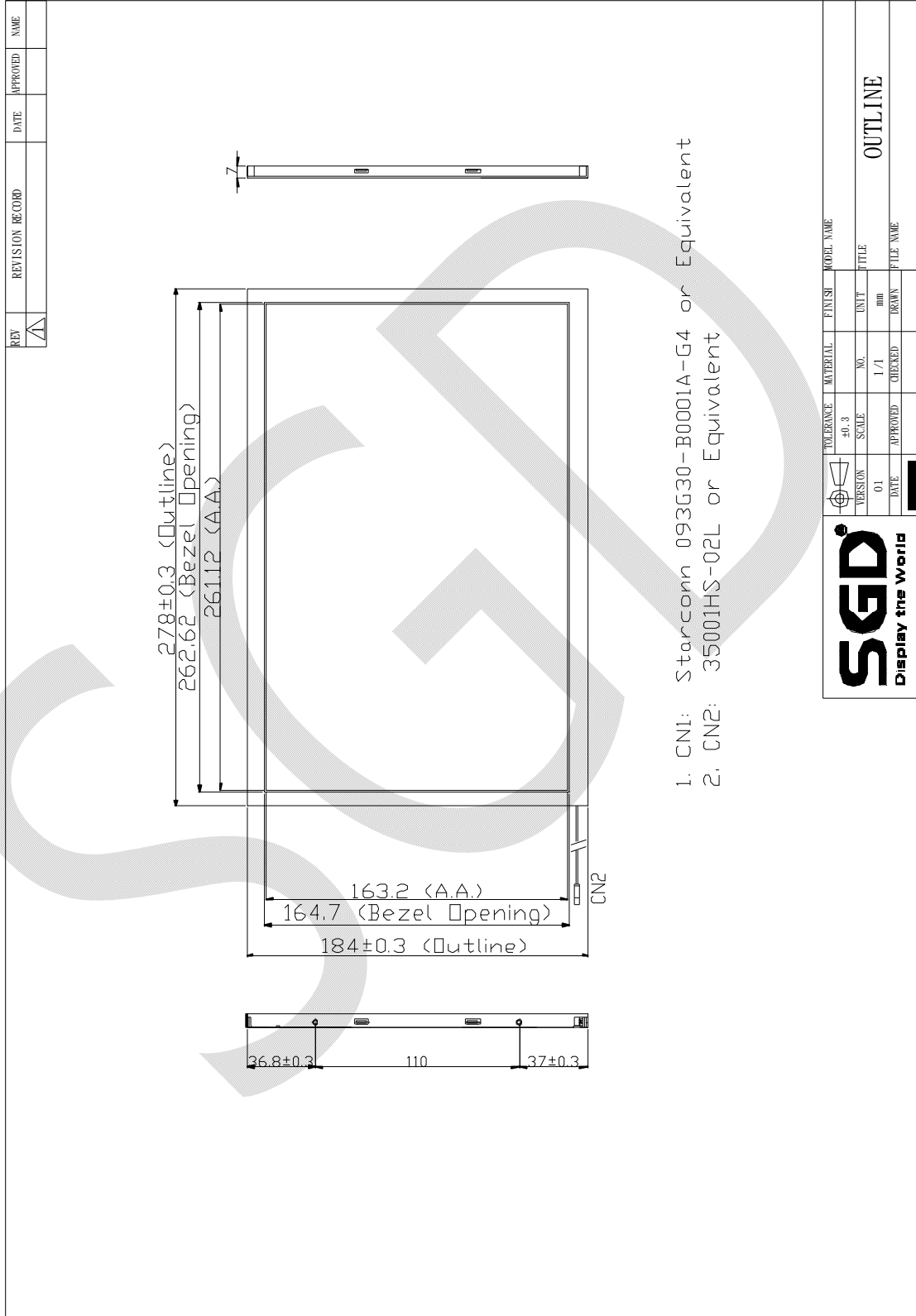

# Product Specification



Model: GKVGC1MNDK2A0

Rev. No.

Issued Date.

Page.

C

2014/DEC/09

18 / 18

REV	REVISION RECORD	DATE	APPROVED	NAME
A				

TOLERANCE	MATERIAL	FINISH	MODEL NAME
±0.3			
SCALE	NO.	UNIT	TITLE
01	1/1	mm	OUTLINE
DATE	APPROVED	CHECKED	DRAWN
2014.12.08			



# LCM Inspection Specification

產品型號/Model No.: **T121ONN01**

<若未標明特定產品型號則視為認可全應用機種/We may deem that you have approved all model if no model list above>

**Version:A**

## CONTENTS

**ISSUE:NOV.22.2013**

No.	ITEM	PAGE
1	COVER	--
2	RECORD OF REVISION	2
3	DESCRIPTION	3
4	INSPECTION AND ENVIRONMENT CONDITIONS	3
5	INSPECTION CRITERIA	4 ~ 7

2. RECORD OF REVISION

Rev	DATE	PAGE	SUMMARY

### 3.適用範圍/Description

此份文件適用於富相科技生產之 12.1” TFT 模組

This document shall be applied to TFT-LCD Module for 12.1” TFT

### 4.檢查條件與環境/ Inspection and Environment Conditions

#### 4.1 檢查條件/ Inspection Conditions:

(1) 檢測距離/Inspection Distance: 35 cm±5cm

(2) 觀看角度/ View Angle:

點燈檢驗角度/ Light-on Inspection Angle : ±5°

外觀檢驗角度/ Cosmetic Inspection Angle : ±45°

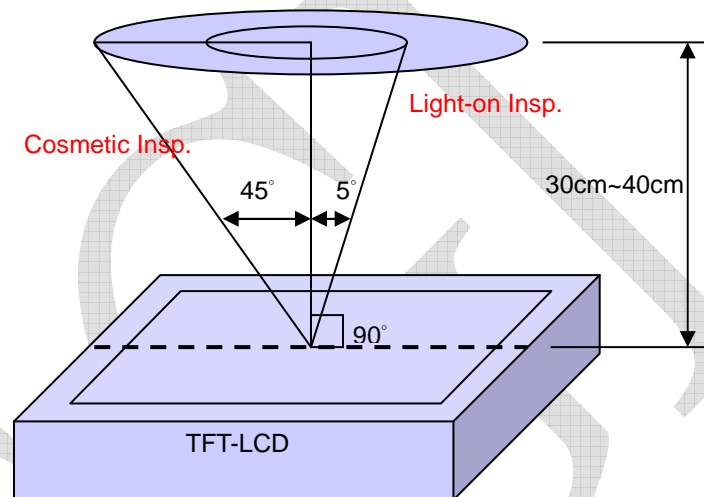

(垂直於液晶顯示表面/ perpendicular to LCD panel surface)

#### 4.2 環境條件/Environment Conditions:

溫度/ Ambient Temperature		23°C±5°C
濕度/ Ambient Humidity		55±10%RH
亮度 Ambient Illumination	外觀檢驗 Cosmetic Inspection	more than 600 Lux
	點燈檢驗 Functional Inspection	300~500 Lux

#### 4.3 抽樣條件/Sampling Conditions:

(1) 批量：單次運送單一機種之數量

Lot Size: Quantity of shipment lot per model

(2) 抽樣方法/Sampling Method:

抽樣計畫 Sampling Plan		MIL-STD-105E
		正常檢驗、單次抽樣 Normal Inspection, Single Sampling
		Level II
AQL	主要缺點 Major Defect	1.0%
	次要缺點 Minor Defect	1.5%

(3) 主缺(MA)及次缺(MI)定義於”3.檢查標準”

The classification of Major(MA) and Minor(MI) defects is shown as 3. Inspection Criteria.

### 5. 檢查標準/ Inspection Criteria

#### 5.1 外觀檢查(面板)/Cosmetic Inspection(Panel):

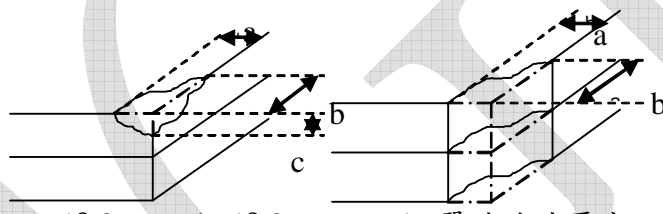
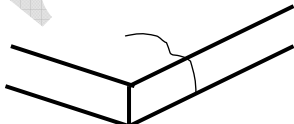
項目/Item	判斷標準/Judgment Criteria	分類/Classification
面板缺角 Chipping on Panel	 <p><math>a \leq 3.0\text{mm}</math>、<math>b \leq 3.0\text{mm}</math>、<math>c \leq t</math> 單片玻璃厚度 (Bottom glass thickness)</p>	MA
面板表面刮傷 Scratch on Panel *Note-2	<p>1.BM: Ignored 2.Pixel area <math>W \leq 0.05\text{mm}</math> or <math>L &lt; 5\text{mm}</math>: Ignored/不計 <math>0.05\text{mm} &lt; W \leq 0.1\text{mm}</math> and <math>L \leq 5\text{mm}</math>: <math>N \leq 5</math> <math>W &gt; 0.1\text{mm}</math> or <math>L &gt; 5\text{mm}</math>: Not allowed/不允許</p>	MI
面板 表面氣泡,凹痕 Bubble or Dent on Panel/Touch Panel *Note-3	<p>1.BM: Ignored 2.Pixel area <math>D \leq 0.2\text{mm}</math>: Ignored/不計 <math>0.2\text{mm} &lt; D \leq 0.3\text{mm}</math>: <math>N \leq 5</math> <math>D &gt; 0.3\text{mm}</math>: Not allowed/不允許</p>	MI
面板裂痕 Panel Crack	 <p>不允許裂痕/ Not Allowed crack</p>	MA
鐵殼變型 Bezel Deformation	<p>不允許明顯的變形 Obvious deformation is not allowed.</p>	MI

鐵殼氧化 Bezel Oxidation	生鏽不可連續超過一公分(馬口鐵不保證) Not allowed if it rusts continuously over 1 cm (It is out of warranty with rusted tin plate)	MI
鐵殼刮傷 Bezel Scratch	鐵件無感刮傷忽略; 鐵件有感刮傷 $L \leq 20\text{mm}$ , $W \leq 0.2$ , $N \leq 3$	MI
鐵件壓痕/凹/凸點 (A面) Metal Squash Dent /Flange(Front Side)	$D(W) \leq 1, L \leq 3, N \leq 3;$	MI
背光高壓線裸露 B/L High Voltage Wire Denudation	不允許 Not allowed	MA
偏光片脫膠/殘膠/ 溢膠 Polarizer flaw or leak out resin	顯示領域範圍內不可 Defect is defined as the active area.	MI
外觀尺寸 Outline Dimension	需符合 Product Spec.所示之規格 Must in Spec, refer to related product spec.	MI

## 5.2 點燈檢查/ Functional Inspection:

項目/ Item	判斷標準/ Judgment Criteria			分類/ Classification
	Area(Note 1)	I	O	
點缺陷 Point Defect	Bright dot 亮點	Random	5	
		2dots adjacent	$N \leq 1$	
		3 dots adjacent or more	$N \leq 0$	
	Bark dot 暗點	Random	5	
		2dots adjacent	$N \leq 1$	
		3 dots adjacent or more	$N \leq 0$	
	Distance 距離	Distance between Bright and Bright dot	$L \geq 10\text{mm}$	
		Distance between Bright and Dark dot	$L \geq 10\text{mm}$	
		Distance between Dark dot	$L \geq 10\text{mm}$	
(1)缺陷大小>0.5dot 定義為點缺陷 It is defined as Point Defect if defect area > 0.5dot (2)缺陷大小≤0.5dot 不計 It is ignored if defect area ≤ 0.5dot (3)微弱亮透過 ND Filter 6%仍可視計為點缺陷(全黑畫面檢查) Weak point defect will be defined as Bright Dot if it can be observed through ND filter 6%( Full Screen Black Inspection)				
線缺陷 Line Defect	不允許明顯的線缺陷 Obvious vertical or horizontal line defect is not allowed.			MA

Mura	不允許任何透過 ND Filter 6 % 仍可視之 Mura Not allowed if it can be observed through ND Filter 6 %	MI
點狀異物 Foreign Material in spot shape *Note-3	Visible under : ND6% D ≤ 0.2mm: Ignored/不計 0.2mm < D ≤ 0.5mm: N ≤ 5 D > 0.5mm: Not allowed/不允許	MI
線狀異物 Foreign Material in line or spiral shape *Note-4	Visible under : ND6% W ≤ 0.05mm or L ≤ 6.0mm: Ignored/不計 0.05mm < W ≤ 0.5mm and L ≤ 6.0mm: N ≤ 5 W > 0.5mm or L > 6.0mm: Not allowed/不允許	MI
顯示異常 Display Function Abnormal	不允許任何顯示異常 No Malfunction can be allowed	MA

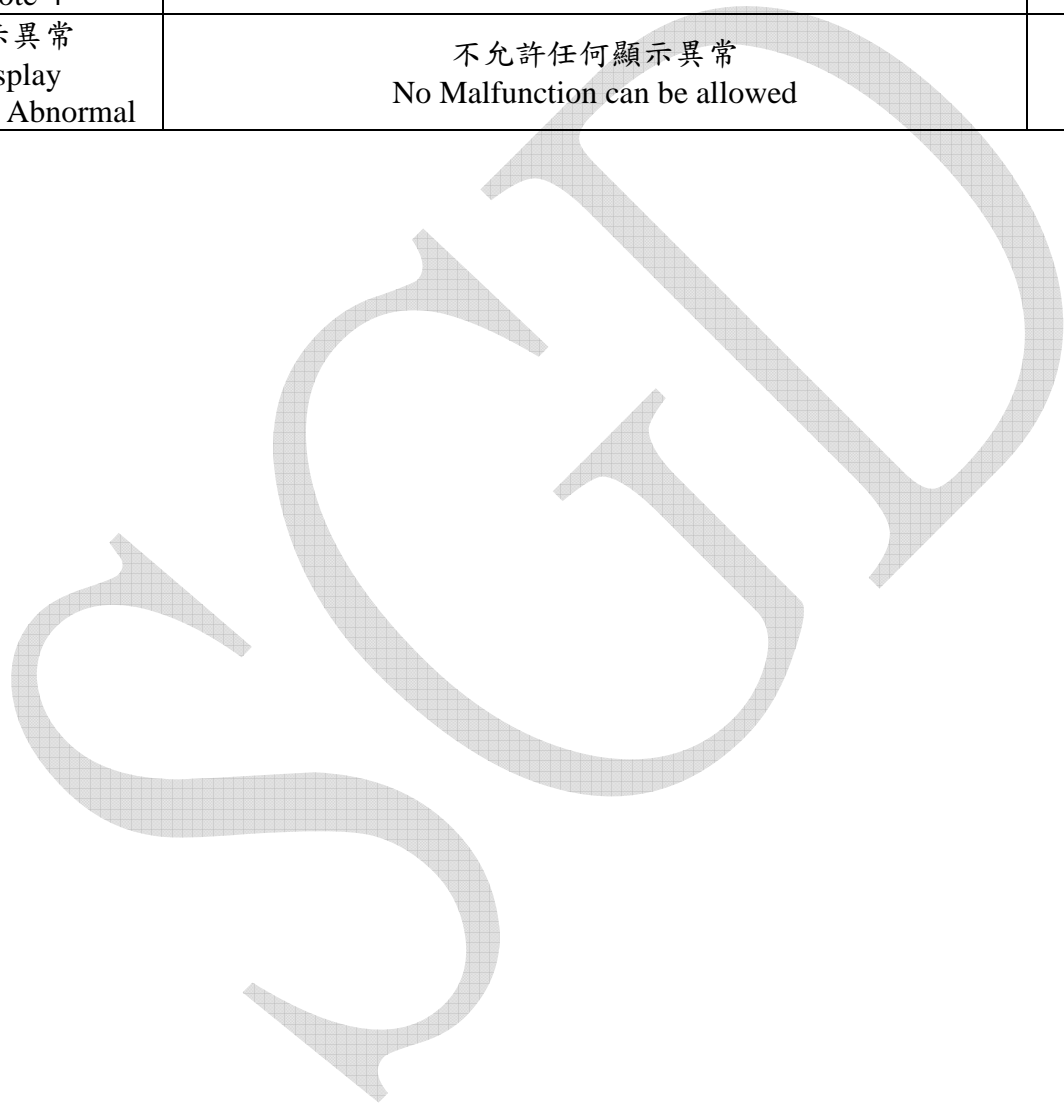



Note-1 : I/O 區定義 / I/O Area Definition

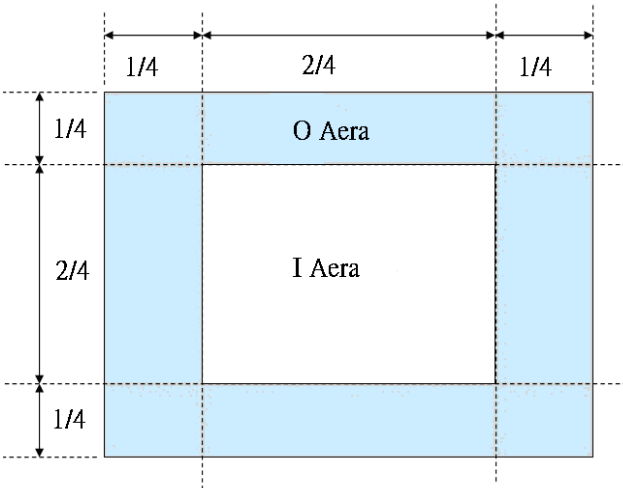

Note-2 : Polarizer 刮傷 / Polarizer Scratch

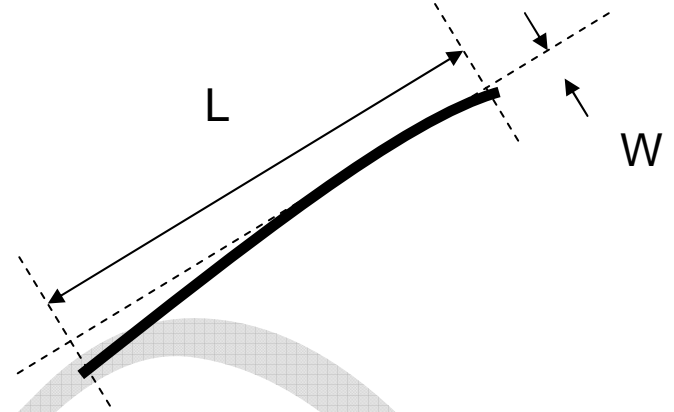

Note-3 : 點狀異物 / Spot Foreign Material  
 ( $W \geq L / 4$ )

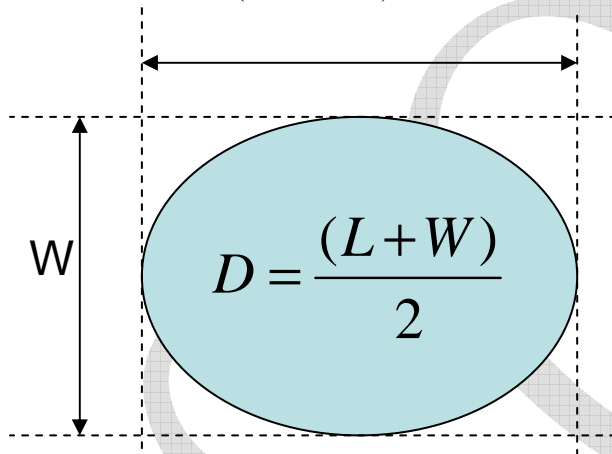

Note-4 : 線狀異物 Line or Spiral Foreign Material  
 ( $W < L / 4$ )

