

**Product Specification**

|   |                      |          |              |        |
|---|----------------------|----------|--------------|--------|
|  | Model: GVTQ35SPAD2R0 | Rev. No. | Issued Date. | Page.  |
|   |                      | A        | Sep,27,10    | 1 / 21 |





**Thin-Film-Transistor LCD Module  
Model: GVTQ35SPAD2R0**

| Acceptance |
|------------|
|            |

**Solomon Goldentek Display Corp.**

**NO. 18 Ta-Yeh St., Ta-Fa Industrial Park, Ta-Liao  
Hsiang, Kaohsiung Hsien 831, TAIWAN , R.O.C.  
FAX: 886-7-7886800**

| Approved and Checked by |
|-------------------------|
|                         |

| Approved by   | Checked by  |  | Made by   |
|---|---|--|---|
|  |  |  |  |

## Product Specification

|   |                      |          |              |        |
|---|----------------------|----------|--------------|--------|
|  | Model: GVTQ35SPAD2R0 | Rev. No. | Issued Date. | Page.  |
|   |                      | A        | Sep,27,10    | 2 / 21 |

### Revise Records

| Rev. | Date       | Contents                              | Written | Approved |
|------|------------|---------------------------------------|---------|----------|
| A    | 2010/06/25 | Preliminary Specification             | Kobe su | Sychang  |
| A    | 2010/09/27 | Revised Display color to 262k colors. | Kobe su | Sychang  |
|      |            |                                       |         |          |
|      |            |                                       |         |          |
|      |            |                                       |         |          |
|      |            |                                       |         |          |
|      |            |                                       |         |          |
|      |            |                                       |         |          |
|      |            |                                       |         |          |
|      |            |                                       |         |          |

### Special Notes

|        |  |
|--------|--|
| Note1. |  |
| Note2. |  |
| Note3. |  |
| Note4. |  |
| Note5. |  |
|        |  |
|        |  |
|        |  |
|        |  |
|        |  |
|        |  |
|        |  |
|        |  |
|        |  |
|        |  |
|        |  |
|        |  |
|        |  |
|        |  |
|        |  |
|        |  |

## Product Specification

|   |                      |          |              |        |
|---|----------------------|----------|--------------|--------|
|  | Model: GVTQ35SPAD2R0 | Rev. No. | Issued Date. | Page.  |
|   |                      | A        | Sep,27,10    | 3 / 21 |

## Contents

|   |    |
|---|----|
| <b>1. General Description and Features</b> .....  | 4  |
| 1.1 Features.....                                 | 4  |
| 1.2 LCD Module.....                               | 4  |
| <b>2. Mechanical Information</b> .....            | 5  |
| <b>3. Electrical Specifications</b> .....         | 6  |
| 3.1 Absolute Max. Ratings.....                    | 6  |
| 3.2 Electrical Absolute Rating.....               | 7  |
| <b>4 Electrical Characteristics</b> .....         | 8  |
| 4.1 TFT-LCD Module (DC Characteristics).....      | 8  |
| 4.2 Backlight Unit.....                           | 9  |
| <b>5 Touch Screen Panel Specifications</b> .....  | 10 |
| 5.1 Touch Screen Panel Specifications.....        | 10 |
| <b>6 Block Diagram</b> .....                      | 11 |
| TFT-LCD Module with Backlight Unit.....           | 11 |
| <b>7 Input Terminal Pin Assignment</b> .....      | 12 |
| 7.1 Pin Assignment (LCD).....                     | 12 |
| <b>8 Optical Characteristics</b> .....            | 14 |
| <b>9 Basic Display Color and Gray Scale</b> ..... | 17 |
| <b>10 Interface Timing</b> .....                  | 18 |
| 10.1 Input Signal Characteristics.....            | 18 |
| 10.2 Waveform.....                                | 19 |
| 10.3 Power On/Off Sequence.....                   | 19 |
| <b>11 Reliability Condition for LCD</b> .....     | 20 |
| <b>12 Dimensional outlines</b> .....              | 21 |

## Product Specification

|   |                      |          |              |        |
|---|----------------------|----------|--------------|--------|
|  | Model: GVTQ35SPAD2R0 | Rev. No. | Issued Date. | Page.  |
|   |                      | A        | Sep,27,10    | 4 / 21 |

### 1. General Description and Features

GVTQ35SPAD2R0 is a TM (Transmissive) type color active matrix TFT (Thin Film Transistor) liquid crystal display (LCD) that uses amorphous silicon TFT as a switching device. This model is composed of a TFT-LCD module, a driver circuit and a back-light unit and a touch screen panel (TSP). The resolution of a 3.5" contains 320RGBx240 dots and can display up to 262K colors. The following table described the features of GVTQ35SPAD2R0.

#### 1.1 Features

- QVGA(320 x 240 pixels) resolution.
- Display in 262K colors.
- On-chip voltage generator.
- SYNC mode is supported for digital RGB input data format.

#### 1.2 LCD Module

| Item               | Specification                 | Unit     |
|--------------------|-------------------------------|----------|
| Screen Size        | 3.5 inches                    | Diagonal |
| Display Resolution | 320 x RGB x 240               | Dot      |
| Dot Pitch          | 0.073 (H) x 0.219 (V)         | mm       |
| Active Area        | 70.08 (H) x 52.56 (V)         | mm       |
| Outline Dimension  | 76.9 (W) x 63.9 (H) x 4.4 (D) | mm       |
| Display Mode       | Normally white/Transmissive   | --       |
| Pixel Arrangement  | RGB-Stripe                    | --       |
| Surface Treatment  | Anti-glare (AG)               | --       |
| Display Color      | 262K                          | --       |
| Viewing Direction  | 6 o'clock (Gray Inversion)    | --       |
| Input Interface    | Digital 8-bits color RGB      | --       |
| Color Gamut        | NTSC 60%                      | --       |

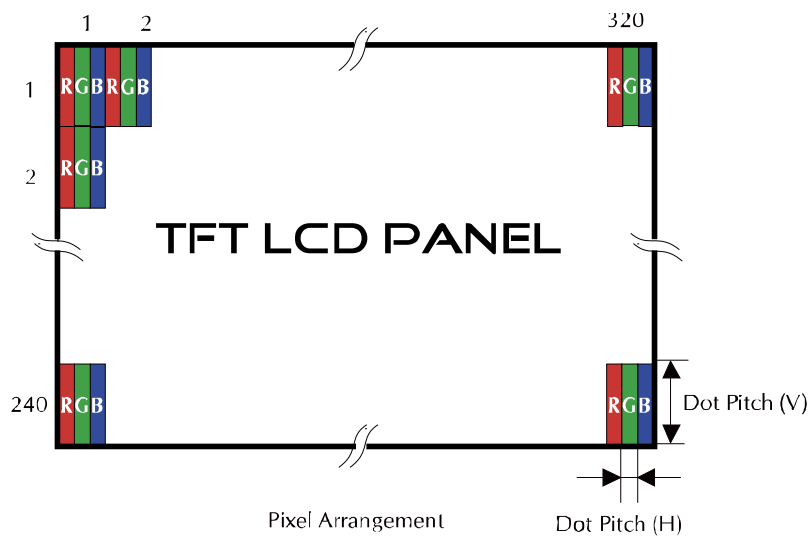

## Product Specification

|   |                      |          |              |        |
|---|----------------------|----------|--------------|--------|
|  | Model: GVTQ35SPAD2R0 | Rev. No. | Issued Date. | Page.  |
|   |                      | A        | Sep,27,10    | 5 / 21 |

### 2. Mechanical Information

| Item        | Min.           | Typ. | Max.  | Unit | Note |     |
|-------------|----------------|------|-------|------|------|-----|
| Module Size | Horizontal (H) | --   | 76.90 | --   | mm   | --  |
|             | Vertical (V)   | --   | 63.90 | --   | mm   | (1) |
|             | Thickness (T)  | --   | 4.40  | --   | mm   | (2) |
| Weight      | --             | 41.9 | --    | g    | --   |     |

Note (1) Not include FPC.

Refer to the Outline Dimension for further information.

## Product Specification

|   |                      |          |              |        |
|---|----------------------|----------|--------------|--------|
|  | Model: GVTQ35SPAD2R0 | Rev. No. | Issued Date. | Page.  |
|   |                      | A        | Sep,27,10    | 6 / 21 |

### 3. Electrical Specifications

#### 3.1 Absolute Max. Ratings

##### 3.1.1 Absolute Ratings of Environment

If the operating condition exceeds the following absolute maximum ratings, the TFT LCD module may be damaged permanently.

(Ta=25±2°C, V<sub>SS</sub>=GND=0)

| Item                  | Symbol           | Min. | Max. | Unit | Note    |
|-----------------------|------------------|------|------|------|---------|
| Storage temperature   | T <sub>STG</sub> | -30  | 80   | °C   | (1)     |
| Operating temperature | T <sub>OPR</sub> | -20  | 70   | °C   | (1,2,3) |

Note (1) 95 % RH Max. ( 40 °C ≥ Ta ). Maximum wet-bulb temperature at 39 °C or less. (Ta > 40 °C)  
No condensation.

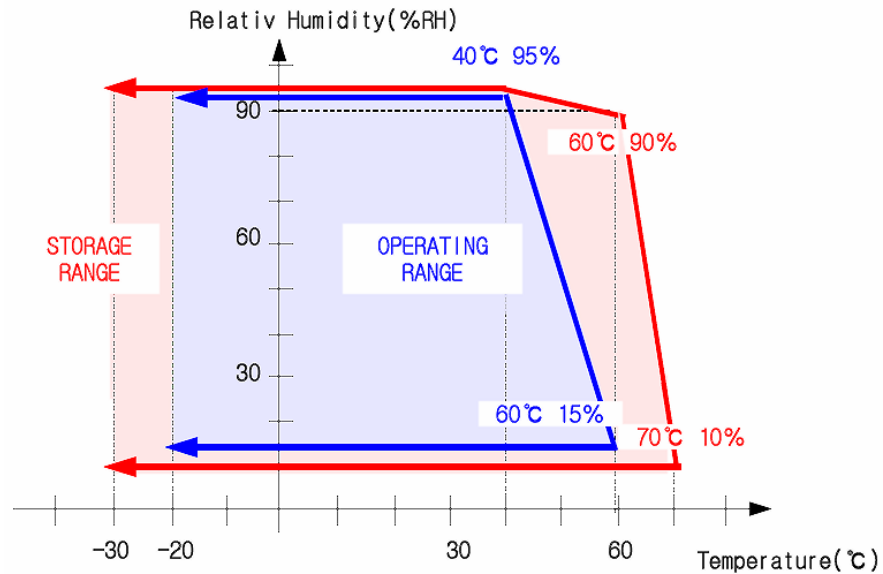

Note (2) In case of below 0°, the response time of liquid crystal (LC) becomes slower and the color of panel becomes darker than normal one. Level of retardation depends on temperature, because of LC's character

Note (3) Only operation is guaranteed at operating temperature. Contrast, response time, another display quality are evaluated at +25°C.

## Product Specification

|   |                      |          |              |        |
|---|----------------------|----------|--------------|--------|
|  | Model: GVTQ35SPAD2R0 | Rev. No. | Issued Date. | Page.  |
|   |                      | A        | Sep,27,10    | 7 / 21 |

### 3.2 Electrical Absolute Rating

#### 3.2.1 TFT-LCD Module

(Voltage Referenced to VSS)

| Item                         | Symbol | Value   |      | Unit | Condition |
|------------------------------|--------|---------|------|------|-----------|
|                              |        | Min.    | Max. |      |           |
| Digital Power Supply Voltage | Vcc    | VSS-0.3 | 5.0  | V    | --        |

#### 3.2.2 Back-Light Unit

(Ta=25±2°C)

| Item            | Symbol         | Min. | Max. | Unit | Note |
|-----------------|----------------|------|------|------|------|
| Forward current | I <sub>f</sub> | --   | (60) | mA   | (1)  |
| Reverse voltage | V <sub>R</sub> | --   | (15) | V    | (1)  |

Note (1) Permanent damage to the device may occur if maximum values are exceeded or reverse voltage is loaded. Functional operation should be restricted to the conditions described under normal operating conditions.

## Product Specification

|   |                      |          |              |        |
|---|----------------------|----------|--------------|--------|
|  | Model: GVTQ35SPAD2R0 | Rev. No. | Issued Date. | Page.  |
|   |                      | A        | Sep,27,10    | 8 / 21 |

### 4 Electrical Characteristics

#### 4.1 TFT-LCD Module (DC Characteristics)

| Item                         | Symbol   | Value        |         |              | Unit | Note |
|------------------------------|----------|--------------|---------|--------------|------|------|
|                              |          | Min.         | Typ.    | Max.         |      |      |
| Digital Power Supply Voltage | $V_{CC}$ | 2.5          | 3.3     | 3.6          | V    |      |
| Input High Threshold Voltage | $V_{IH}$ | $0.8 V_{CC}$ | -       | $V_{CC}$     | V    |      |
| Input Low Threshold Voltage  | $V_{IL}$ | 0            | -       | $0.2 V_{CC}$ | V    |      |
| Power Supply Current         | $I_{CC}$ | -            | (15.6)  | (22.0)       | mA   | (1)  |
| Power Consumption            | $P_L$    | -            | (51.48) | (72.6)       | mW   | (1)  |

Note (1) The specified power consumption is under the conditions at  $V_{CC}=3.3V$  ,  $F_V=60Hz$ , whereas a Power dissipation check pattern below is displayed.

Black Pattern / 0 Gray

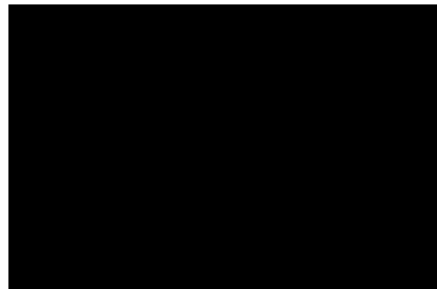

Active Area



## Product Specification

|   |                      |          |              |        |
|---|----------------------|----------|--------------|--------|
|  | Model: GVTQ35SPAD2R0 | Rev. No. | Issued Date. | Page.  |
|   |                      | A        | Sep,27,10    | 9 / 21 |

### 4.2 Backlight Unit

The back-light system is an edge-lighting type with six white LEDs (Light Emitting Diode).

(Ta=25±2°C)

| Item                | Symbol          | Value   |       |      | Unit | Condition |
|---------------------|-----------------|---------|-------|------|------|-----------|
|                     |                 | Min.    | Typ.  | Max. |      |           |
| LED Voltage         | VL              | -       | (9.9) | -    | V    |           |
| LED Current         | IL              | -       | (40)  | -    | mA   |           |
| Power Consumption   | P <sub>BL</sub> | -       | (396) | -    | mW   |           |
| LED Life Time(25°C) | -               | (20000) | -     | -    | hr   |           |

Note (1) Where  $I_B = 40\text{mA}$ ,  $V_F = 9.9$ ,  $P_{BL} = V_F \times I_B$

## Product Specification

|   |                      |          |              |         |
|---|----------------------|----------|--------------|---------|
|  | Model: GVTQ35SPAD2R0 | Rev. No. | Issued Date. | Page.   |
|   |                      | A        | Sep,27,10    | 10 / 21 |

### 5 Touch Screen Panel Specifications

#### 5.1 Touch Screen Panel Specifications

##### 5.1.1 Electrical Characteristics

| Item                  | Min. | Typ. | Max. | Unit       | Note                      |
|-----------------------|------|------|------|------------|---------------------------|
| Linearity             | -1.5 | -    | 1.5  | %          | Analog X and Y directions |
| Terminal resistance   | 200  | -    | 900  | $\Omega$   | X (Glass side)            |
|                       | 200  | -    | 900  | $\Omega$   | Y (Film side)             |
| Insulation resistance | 20   | -    | -    | M $\Omega$ | DC 25V                    |
| Voltage               | -    | 5.0  | 7.0  | V          | DC                        |
| Chattering            | -    | -    | 10   | ms         | 100k $\Omega$ pull-up     |

Caution (1) : Do not operate it with a thing except a polyacetal pen (tip R0.8mm or less) or a finger, especially those with hard or sharp tips such as a ball point pen or a mechanical pencil.

##### 5.1.2 Mechanical & Reliability Characteristics

| Item                          | Min.             | Typ. | Max. | Unit       | Note                 |
|-------------------------------|------------------|------|------|------------|----------------------|
| Activation force              | -                |      | 80   | g          | (1)                  |
| Durability-surface scratching | Write<br>100,000 | -    | -    | characters | (2)                  |
| Durability-surface pitting    | 1,000,000        | -    | -    | touches    | (3)                  |
| Surface hardness              | 3                | -    | -    | H          | JIS K5400,ASTM D3363 |

Note (1) Stylus pen Input : R0.8mm polyacetal pen or Finger

Note (2) Measurement for Surface area - Scratch 100,000 times straight line on the Film with a stylus change every 20,000times

- Force : 150gf
- Speed : 100mm/sec
- Stylus : R0.8 polyacetal tip

Note (2) Pit 1,000,000 times on the Film with a R8.0 silicon rubber.

- Force : Force : 250gf
- Speed : 3times/sec

## Product Specification

|   |                      |          |              |         |
|---|----------------------|----------|--------------|---------|
|  | Model: GVTQ35SPAD2R0 | Rev. No. | Issued Date. | Page.   |
|   |                      | A        | Sep,27,10    | 11 / 21 |

### 6 Block Diagram

TFT-LCD Module with Backlight Unit

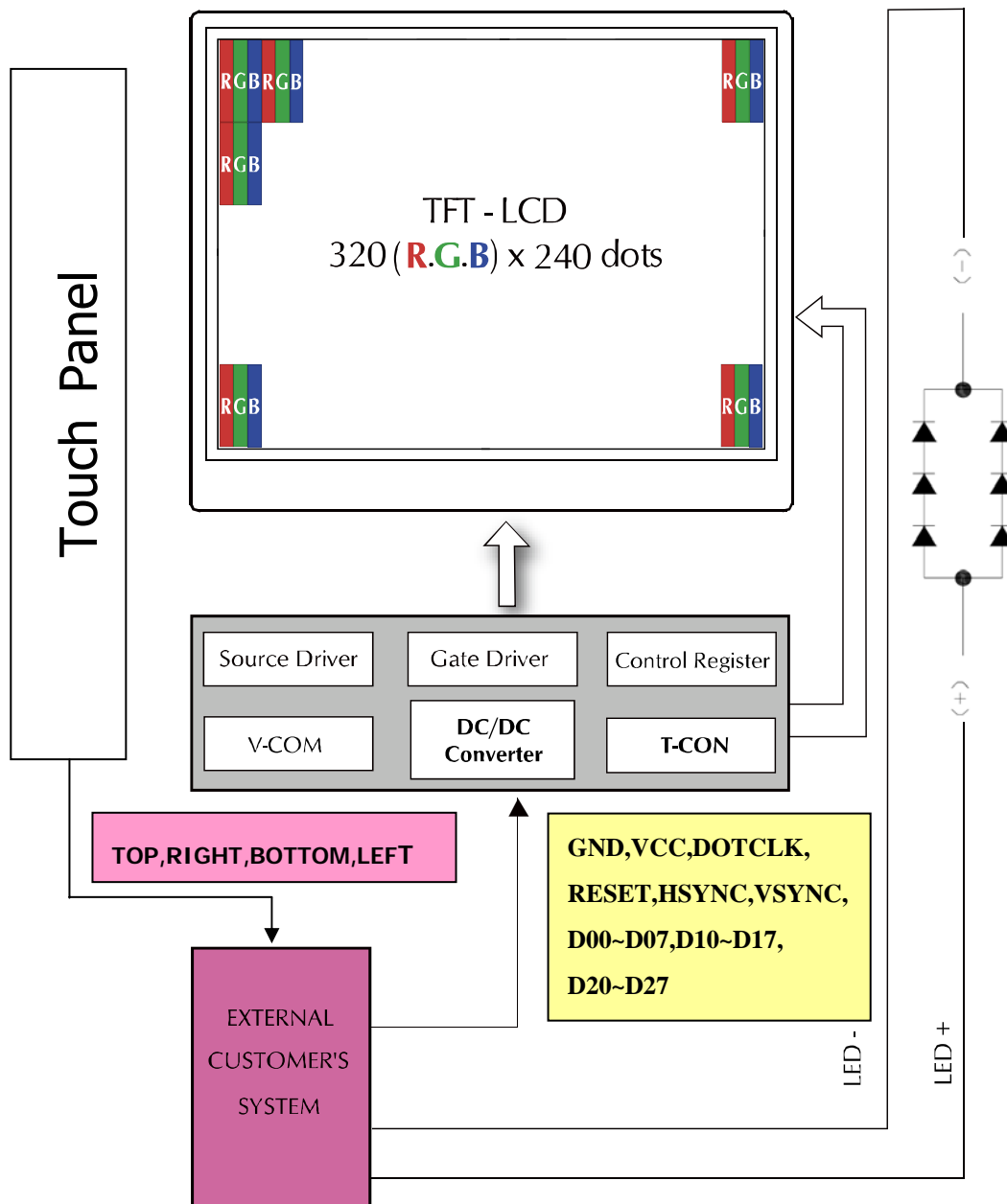

## Product Specification

|   |                      |          |              |         |
|---|----------------------|----------|--------------|---------|
|  | Model: GVTQ35SPAD2R0 | Rev. No. | Issued Date. | Page.   |
|   |                      | A        | Sep,27,10    | 12 / 21 |

### 7 Input Terminal Pin Assignment

#### 7.1 Pin Assignment (LCD)

| Pin No. | Symbol | I/O | Function             | Remark |
|---------|--------|-----|----------------------|--------|
| 1       | LED_K  | I   | Backlight LED Ground |        |
| 2       | LED_K  | I   | Backlight LED Ground |        |
| 3       | LED_A  | I   | Backlight LED Power  |        |
| 4       | LED_A  | I   | Backlight LED Power  |        |
| 5       | N/C    | I   | Not Connection       |        |
| 6       | N/C    | I   | Not Connection       |        |
| 7       | N/C    | I   | Not Connection       |        |
| 8       | RESET  | I   | Hardware Reset       |        |
| 9       | NC     | I   | Not Connection       |        |
| 10      | NC     | I   | Not Connection       |        |
| 11      | NC     | --  | Not Connection       |        |
| 12      | D20    | I   | Blue Data (LSB)      |        |
| 13      | D21    | I   | Blue Data            |        |
| 14      | D22    | I   | Blue Data            |        |
| 15      | D23    | I   | Blue Data            |        |
| 16      | D24    | I   | Blue Data            |        |
| 17      | D25    | I   | Blue Data            |        |
| 18      | D26    | I   | Blue Data            |        |
| 19      | D27    | I   | Blue Data (MSB)      |        |
| 20      | D10    | I   | Green Data (LSB)     |        |
| 21      | D11    | I   | Green Data           |        |
| 22      | D12    | I   | Green Data           |        |
| 23      | D13    | I   | Green Data           |        |
| 24      | D14    | I   | Green Data           |        |
| 25      | D15    | I   | Green Data           |        |
| 26      | D16    | I   | Green Data           |        |
| 27      | D17    | I   | Green Data (MSB)     |        |
| 28      | D00    | I   | Red Data (LSB)       |        |
| 29      | D01    | I   | Red Data             |        |
| 30      | D02    | I   | Red Data             |        |
| 31      | D03    | I   | Red Data             |        |
| 32      | D04    | I   | Red Data             |        |
| 33      | D05    | I   | Red Data             |        |

## Product Specification

|   |                      |          |              |         |
|---|----------------------|----------|--------------|---------|
|  | Model: GVTQ35SPAD2R0 | Rev. No. | Issued Date. | Page.   |
|   |                      | A        | Sep,27,10    | 13 / 21 |

|    |                    |   |                          |  |
|----|--------------------|---|--------------------------|--|
| 34 | D06                | I | Red Data                 |  |
| 35 | D07                | I | Red Data (MSB)           |  |
| 36 | H <sub>SYNC</sub>  | I | Horizontal Sync Input    |  |
| 37 | V <sub>SYNC</sub>  | I | Vertical Sync Input      |  |
| 38 | D <sub>OTCLK</sub> | I | Dot Data Clock           |  |
| 39 | N/C                | I | Not Connection           |  |
| 40 | N/C                | I | Not Connection           |  |
| 41 | VCC                | I | For system power supply. |  |
| 42 | VCC                | I | For system power supply. |  |
| 43 | N/C                | I | Not Connection           |  |
| 44 | N/C                | I | Not Connection           |  |
| 45 | YU                 | I | Touch Panel Top Side     |  |
| 46 | XR                 | I | Touch Panel Right Side   |  |
| 47 | YD                 | I | Touch Panel Bottom Side  |  |
| 48 | XL                 | I | Touch Panel Left Side    |  |
| 49 | N/C                | I | Not Connection           |  |
| 50 | N/C                | I | Not Connection           |  |
| 51 | N/C                | I | Not Connection           |  |
| 52 | N/C                | I | Not Connection           |  |
| 53 | GND                | I | Ground                   |  |
| 54 | GND                | I | Ground                   |  |

## Product Specification

|   |                      |          |              |         |
|---|----------------------|----------|--------------|---------|
|  | Model: GVTQ35SPAD2R0 | Rev. No. | Issued Date. | Page.   |
|   |                      | A        | Sep,27,10    | 14 / 21 |

### 8 Optical Characteristics

The following items are measured under stable conditions. The optical characteristics should be measured in a dark room or equivalent state with the methods shown in Note (1).

Measuring equipment: BM-5A, BM-7,

(Ta=25±2°C)

| Item                         |       | Symbol           | Condition                             | Min     | Type    | Max     | Unit              | Note |    |
|------------------------------|-------|------------------|---------------------------------------|---------|---------|---------|-------------------|------|----|
| Brightness                   |       | --               | $\theta=0^\circ$ Normal Viewing Angle | (540)   | (640)   | --      | cd/m <sup>2</sup> | --   |    |
| Response time                |       | T <sub>R</sub>   |                                       | --      | 15      | 20      | ms                | --   |    |
|                              |       | T <sub>F</sub>   |                                       | --      | 35      | 50      | ms                |      |    |
| Brightness uniformity        |       | B <sub>UNI</sub> |                                       |         | 80      | -       | -                 | %    |    |
| Contrast ratio               |       | CR               |                                       |         | 300     | 450     | --                | --   | -- |
| Color Chromaticity (CIE1931) | Red   | R <sub>X</sub>   |                                       |         | (0.590) | (0.640) | (0.690)           | --   | -- |
|                              |       | R <sub>Y</sub>   |                                       |         | (0.294) | (0.344) | (0.394)           |      |    |
|                              | Green | G <sub>X</sub>   |                                       |         | (0.248) | (0.298) | (0.348)           | --   |    |
|                              |       | G <sub>Y</sub>   |                                       |         | (0.532) | (0.583) | (0.633)           |      |    |
|                              | Blue  | B <sub>X</sub>   |                                       |         | (0.090) | (0.140) | (0.190)           | --   |    |
|                              |       | B <sub>Y</sub>   |                                       | (0.080) | (0.130) | (0.180) |                   |      |    |
|                              | White | W <sub>X</sub>   |                                       | (0.262) | (0.312) | (0.362) | --                |      |    |
|                              |       | W <sub>Y</sub>   |                                       | (0.299) | (0.349) | (0.399) |                   |      |    |
| Viewing Angle (6H)           | Hor.  | $\theta_R$       | CR≥10                                 | 50      | (60)    | --      | Degree            | --   |    |
|                              |       | $\theta_L$       |                                       | 50      | (60)    | --      |                   |      |    |
|                              | Ver.  | $\phi_H$         |                                       | 40      | (50)    | --      |                   |      |    |
|                              |       | $\phi_L$         |                                       | 50      | (60)    | --      |                   |      |    |

## Product Specification

|   |                      |          |              |         |
|---|----------------------|----------|--------------|---------|
|  | Model: GVTQ35SPAD2R0 | Rev. No. | Issued Date. | Page.   |
|   |                      | A        | Sep,27,10    | 15 / 21 |

a. Test equipment setup

After stabilizing and leaving the panel alone shall be warmed up for the stable operation of LCM, the measurement should be executed. Measurement should be executed in a stable, windless, and dark room. Optical specifications are measured by Topcon BM-7(fast) with a viewing angle of 2° at a distance of 50cm and normal direction.

b. Definition of response time: Tr and Tf

The response time is defined as the following figure and shall be measured by switching the input signal for "black" and "white".

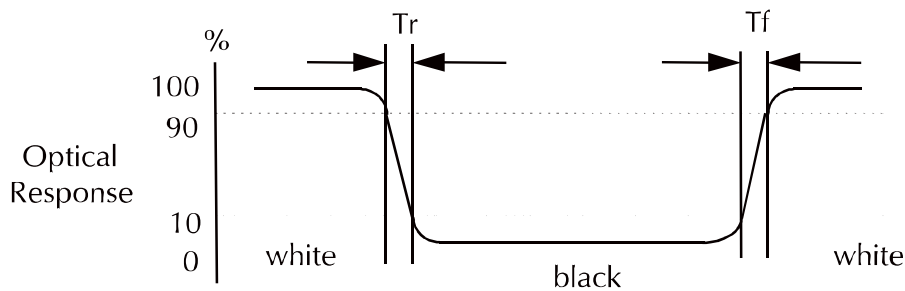

c. Definition of contrast ratio:

Brightness measured when LCD is at "white state"

$$\text{Contrast Ratio (CR)} = \frac{\text{Brightness measured when LCD is at "white state"}}{\text{Brightness measured when LCD is at "black state"}}$$

Brightness measured when LCD is at "black state"

d. Measured at the center area of the panel when all the input terminals of LCD panel are electrically opened.

## Product Specification

|   |                      |          |              |         |
|---|----------------------|----------|--------------|---------|
|  | Model: GVTQ35SPAD2R0 | Rev. No. | Issued Date. | Page.   |
|   |                      | A        | Sep,27,10    | 16 / 21 |

e. View Angle

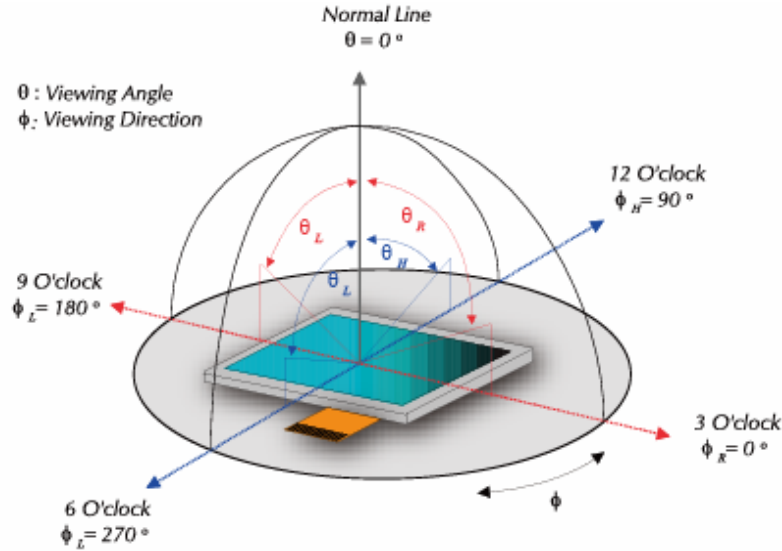

f. Definition of Luminance of White: Luminance of white at the center points

|                                 |          |
|---------------------------------|----------|
| Light Source of Back-Light Unit | LED Type |
|---------------------------------|----------|

g. Definition of White Uniformity

$$\text{White Uniformity} = \frac{\text{Min. luminance of white among 9-points}}{\text{Max. luminance of white among 9-points}}$$

h. The definition of Color Gamut -Color Chromaticity CIE 1931

Color coordinate of white & red, green, blue at center point.

Color Gamut : NTSC(%) = ( RGB Triangle Area / NTSC Triangle Area ) x 100

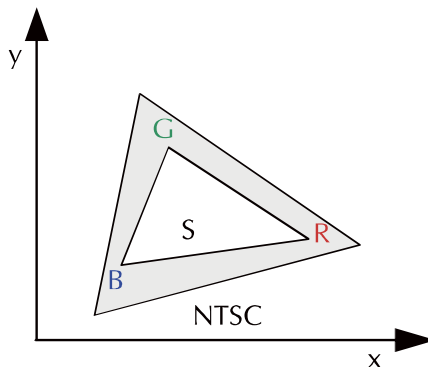



## Product Specification

|   |                      |          |              |         |
|---|----------------------|----------|--------------|---------|
|  | Model: GVTQ35SPAD2R0 | Rev. No. | Issued Date. | Page.   |
|   |                      | A        | Sep,27,10    | 17 / 21 |

### 9 Basic Display Color and Gray Scale

|             | Color & Gray Scale | Data Signal |     |     |     |     |     |     |     |     |     |     |     |     |     |     |     |     |     |     |     |     |     |     |     |
|-------------|--------------------|-------------|-----|-----|-----|-----|-----|-----|-----|-----|-----|-----|-----|-----|-----|-----|-----|-----|-----|-----|-----|-----|-----|-----|-----|
|             |                    | D07         | D06 | D05 | D04 | D03 | D02 | D01 | D00 | D17 | D16 | D15 | D14 | D13 | D12 | D11 | D10 | D27 | D26 | D25 | D24 | D23 | D22 | D21 | D20 |
| Basic Color | Black              | 0           | 0   | 0   | 0   | 0   | 0   | 0   | 0   | 0   | 0   | 0   | 0   | 0   | 0   | 0   | 0   | 0   | 0   | 0   | 0   | 0   | 0   | 0   | 0   |
|             | Red                | 1           | 1   | 1   | 1   | 1   | 1   | 1   | 1   | 0   | 0   | 0   | 0   | 0   | 0   | 0   | 0   | 0   | 0   | 0   | 0   | 0   | 0   | 0   | 0   |
|             | Green              | 0           | 0   | 0   | 0   | 0   | 0   | 0   | 0   | 1   | 1   | 1   | 1   | 1   | 1   | 1   | 1   | 0   | 0   | 0   | 0   | 0   | 0   | 0   | 0   |
|             | Blue               | 0           | 0   | 0   | 0   | 0   | 0   | 0   | 0   | 0   | 0   | 0   | 0   | 0   | 0   | 0   | 0   | 1   | 1   | 1   | 1   | 1   | 1   | 1   | 1   |
|             | Cyan               | 0           | 0   | 0   | 0   | 0   | 0   | 0   | 0   | 1   | 1   | 1   | 1   | 1   | 1   | 1   | 1   | 1   | 1   | 1   | 1   | 1   | 1   | 1   | 1   |
|             | Magenta            | 1           | 1   | 1   | 1   | 1   | 1   | 1   | 1   | 0   | 0   | 0   | 0   | 0   | 0   | 0   | 0   | 1   | 1   | 1   | 1   | 1   | 1   | 1   | 1   |
|             | Yellow             | 1           | 1   | 1   | 1   | 1   | 1   | 1   | 1   | 1   | 1   | 1   | 1   | 1   | 1   | 1   | 1   | 0   | 0   | 0   | 0   | 0   | 0   | 0   | 0   |
|             | White              | 1           | 1   | 1   | 1   | 1   | 1   | 1   | 1   | 1   | 1   | 1   | 1   | 1   | 1   | 1   | 1   | 1   | 1   | 1   | 1   | 1   | 1   | 1   | 1   |
| Red         | Black              | 0           | 0   | 0   | 0   | 0   | 0   | 0   | 0   | 0   | 0   | 0   | 0   | 0   | 0   | 0   | 0   | 0   | 0   | 0   | 0   | 0   | 0   | 0   |     |
|             | Red(1)             | 0           | 0   | 0   | 0   | 0   | 0   | 0   | 1   | 0   | 0   | 0   | 0   | 0   | 0   | 0   | 0   | 0   | 0   | 0   | 0   | 0   | 0   | 0   |     |
|             | Red(2)             | 0           | 0   | 0   | 0   | 0   | 0   | 1   | 0   | 0   | 0   | 0   | 0   | 0   | 0   | 0   | 0   | 0   | 0   | 0   | 0   | 0   | 0   | 0   |     |
|             | :                  | :           | :   | :   | :   | :   | :   | :   | :   | :   | :   | :   | :   | :   | :   | :   | :   | :   | :   | :   | :   | :   | :   | :   |     |
|             | Red(127)           | 0           | 1   | 1   | 1   | 1   | 1   | 1   | 1   | 0   | 0   | 0   | 0   | 0   | 0   | 0   | 0   | 0   | 0   | 0   | 0   | 0   | 0   | 0   |     |
|             | :                  | :           | :   | :   | :   | :   | :   | :   | :   | :   | :   | :   | :   | :   | :   | :   | :   | :   | :   | :   | :   | :   | :   | :   | :   |
|             | Red(254)           | 1           | 1   | 1   | 1   | 1   | 1   | 1   | 0   | 0   | 0   | 0   | 0   | 0   | 0   | 0   | 0   | 0   | 0   | 0   | 0   | 0   | 0   | 0   |     |
|             | Red(255)           | 1           | 1   | 1   | 1   | 1   | 1   | 1   | 1   | 0   | 0   | 0   | 0   | 0   | 0   | 0   | 0   | 0   | 0   | 0   | 0   | 0   | 0   | 0   |     |
| Green       | Black              | 0           | 0   | 0   | 0   | 0   | 0   | 0   | 0   | 0   | 0   | 0   | 0   | 0   | 0   | 0   | 0   | 0   | 0   | 0   | 0   | 0   | 0   | 0   |     |
|             | Green(1)           | 0           | 0   | 0   | 0   | 0   | 0   | 0   | 0   | 0   | 0   | 0   | 0   | 0   | 0   | 0   | 1   | 0   | 0   | 0   | 0   | 0   | 0   | 0   |     |
|             | Green(2)           | 0           | 0   | 0   | 0   | 0   | 0   | 0   | 0   | 0   | 0   | 0   | 0   | 0   | 0   | 1   | 0   | 0   | 0   | 0   | 0   | 0   | 0   | 0   |     |
|             | :                  | :           | :   | :   | :   | :   | :   | :   | :   | :   | :   | :   | :   | :   | :   | :   | :   | :   | :   | :   | :   | :   | :   | :   |     |
|             | Green(127)         | 0           | 0   | 0   | 0   | 0   | 0   | 0   | 0   | 0   | 1   | 1   | 1   | 1   | 1   | 1   | 1   | 0   | 0   | 0   | 0   | 0   | 0   | 0   |     |
|             | :                  | :           | :   | :   | :   | :   | :   | :   | :   | :   | :   | :   | :   | :   | :   | :   | :   | :   | :   | :   | :   | :   | :   | :   |     |
|             | Green(254)         | 0           | 0   | 0   | 0   | 0   | 0   | 0   | 0   | 1   | 1   | 1   | 1   | 1   | 1   | 1   | 0   | 0   | 0   | 0   | 0   | 0   | 0   | 0   |     |
|             | Green(255)         | 0           | 0   | 0   | 0   | 0   | 0   | 0   | 0   | 1   | 1   | 1   | 1   | 1   | 1   | 1   | 0   | 0   | 0   | 0   | 0   | 0   | 0   | 0   |     |
| Blue        | Black              | 0           | 0   | 0   | 0   | 0   | 0   | 0   | 0   | 0   | 0   | 0   | 0   | 0   | 0   | 0   | 0   | 0   | 0   | 0   | 0   | 0   | 0   | 0   |     |
|             | Blue(1)            | 0           | 0   | 0   | 0   | 0   | 0   | 0   | 0   | 0   | 0   | 0   | 0   | 0   | 0   | 0   | 0   | 0   | 0   | 0   | 0   | 0   | 0   | 1   |     |
|             | Blue(2)            | 0           | 0   | 0   | 0   | 0   | 0   | 0   | 0   | 0   | 0   | 0   | 0   | 0   | 0   | 0   | 0   | 0   | 0   | 0   | 0   | 0   | 1   | 0   |     |
|             | :                  | :           | :   | :   | :   | :   | :   | :   | :   | :   | :   | :   | :   | :   | :   | :   | :   | :   | :   | :   | :   | :   | :   | :   |     |
|             | Blue(127)          | 0           | 0   | 0   | 0   | 0   | 0   | 0   | 0   | 0   | 0   | 0   | 0   | 0   | 0   | 0   | 0   | 1   | 1   | 1   | 1   | 1   | 1   | 1   |     |
|             | :                  | :           | :   | :   | :   | :   | :   | :   | :   | :   | :   | :   | :   | :   | :   | :   | :   | :   | :   | :   | :   | :   | :   | :   |     |
|             | Blue(254)          | 0           | 0   | 0   | 0   | 0   | 0   | 0   | 0   | 0   | 0   | 0   | 0   | 0   | 0   | 0   | 1   | 1   | 1   | 1   | 1   | 1   | 1   | 0   |     |
|             | Blue(255)          | 0           | 0   | 0   | 0   | 0   | 0   | 0   | 0   | 0   | 0   | 0   | 0   | 0   | 0   | 0   | 1   | 1   | 1   | 1   | 1   | 1   | 1   | 1   |     |

0 : Low level voltage, 1 : High level voltage

Each basic color can be displayed in 256 gray scales from 8 bit data signals. With the combination of total 24 bit data signals, the 16,777,216-color display can be achieved on the screen.

## Product Specification

|   |                      |          |              |         |
|---|----------------------|----------|--------------|---------|
|  | Model: GVTQ35SPAD2R0 | Rev. No. | Issued Date. | Page.   |
|   |                      | A        | Sep,27,10    | 18 / 21 |

### 10 Interface Timing

#### 10.1 Input Signal Characteristics

##### 9.2.1 Digital Parallel RGB Interface (320\*240 resolution)

| Item                         | Symbol      | Min.   | Typ. | Max.        | Unit    |       |
|------------------------------|-------------|--------|------|-------------|---------|-------|
| DOTCLK Frequency             | fDOTCLK     | -      | 6.5  | 10          | MHz     |       |
| DOTCLK Period                | tDOTCLK     | 100    | 154  | -           | ns      |       |
| Horizontal Frequency (Line)  | fH          | -      | 14.9 | 22.35       | KHz     |       |
| Vertical Frequency (Refresh) | fV          | -      | 60   | 90          | Hz      |       |
| Horizontal Back Porch        | tHBP        | -      | 68   | -           | tDOTCLK |       |
| Horizontal Front Porch       | tHFP        | -      | 20   | -           | tDOTCLK |       |
| Horizontal Data Start Point  | tHBP        | -      | 68   | -           | tDOTCLK |       |
| Horizontal Blanking Period   | tHBP + tHFP | -      | 88   | -           | tDOTCLK |       |
| Horizontal Display Area      | HDISP       | -      | 320  | -           | tDOTCLK |       |
| Horizontal Cycle             | Hcycle      | -      | 408  | 450         | tDOTCLK |       |
| Vertical Back Porch          | tVBP        | -      | 18   | -           | Lines   |       |
| Vertical Front Porch         | tVFP        | -      | 4    | -           | Lines   |       |
| Vertical Data Start Point    | tVBP        | -      | 18   | -           | Lines   |       |
| Vertical Blanking Period     | tVBP + tVFP | -      | 22   | -           | Lines   |       |
| Vertical Display Area        | NTSC        | VDISP  | -    | 240         | -       | Lines |
|                              | PAL         |        |      | 280(PALM=0) |         |       |
|                              |             |        |      | 288(PALM=1) |         |       |
| Vertical Cycle               | NTSC        | Vcycle | -    | 262         | 350     | Lines |
|                              | PAL         |        |      | 313         |         |       |

## Product Specification



Model: GVTQ35SPAD2R0

Rev. No.

Issued Date.

Page.

A

Sep,27,10

19 / 21

### 10.2 Waveform

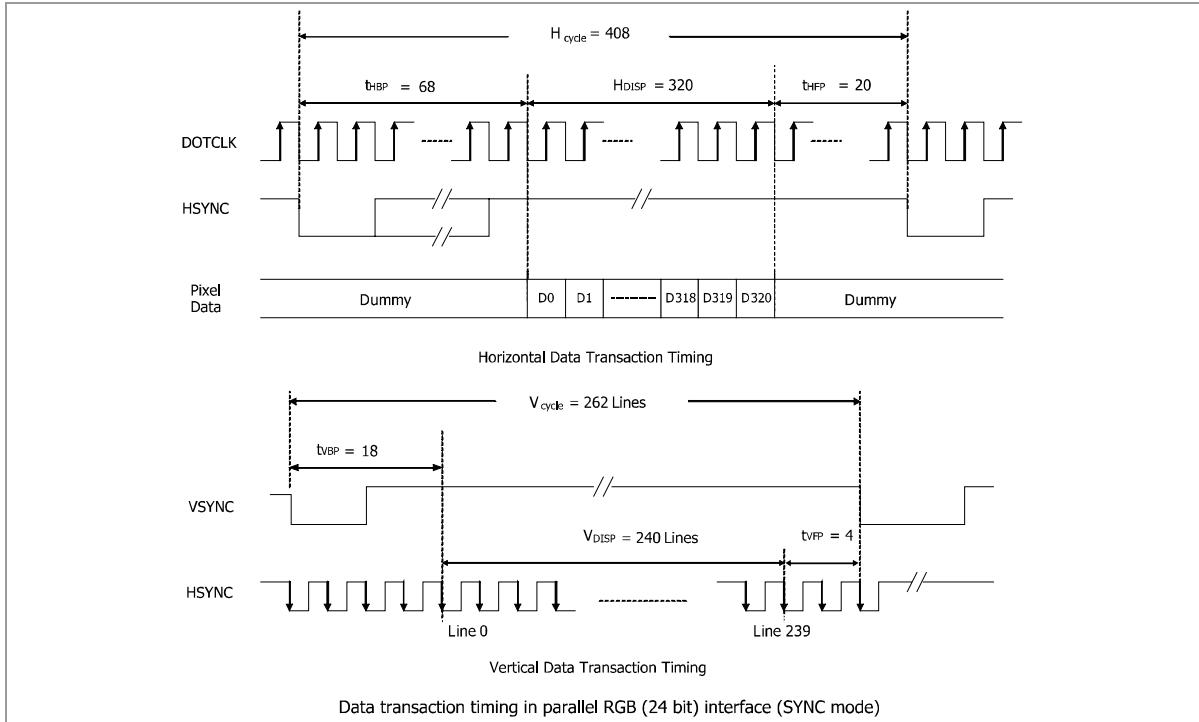

### 10.3 Power On/Off Sequence

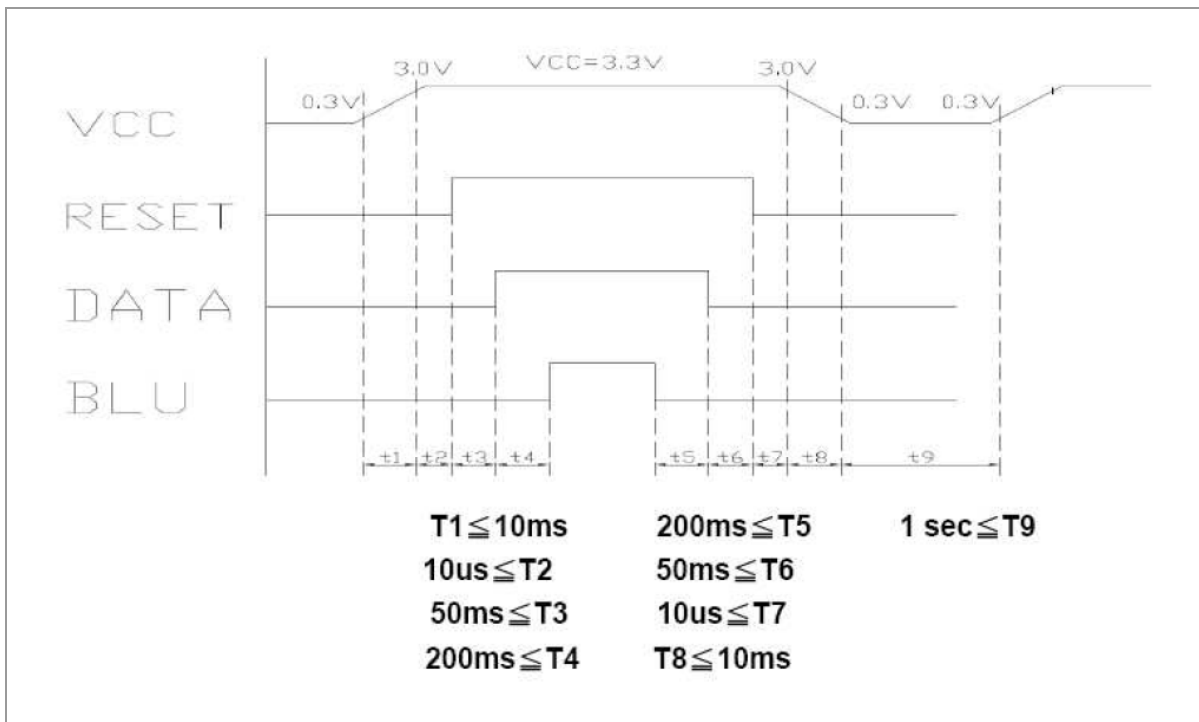

## Product Specification

|   |                      |          |              |         |
|---|----------------------|----------|--------------|---------|
|  | Model: GVTQ35SPAD2R0 | Rev. No. | Issued Date. | Page.   |
|   |                      | A        | Sep,27,10    | 20 / 21 |

### 11 Reliability Condition for LCD

No change on display and in operation under the following test condition.

Condition: Unless otherwise specified, tests will be conducted under the following condition.

Temperature: 20±5°C                      Humidity: 65±5%RH

Tests will be not conducted under functioning state.

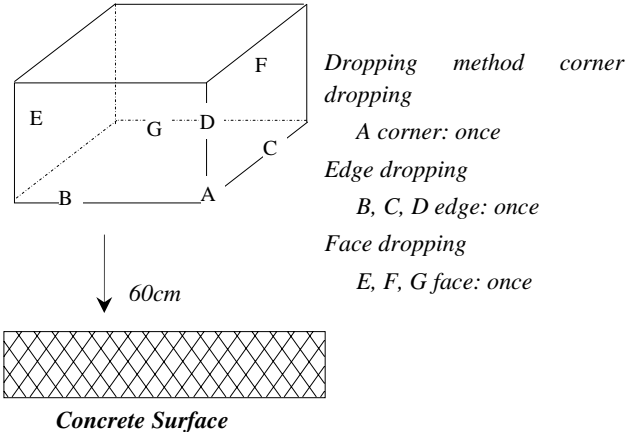
| No. | Parameter   | Condition  | Notes |
|-----|---|--|-------|
| 1   | High Temperature Operating                        | 70°C±2°C, 240hrs (Operation state)   | --    |
| 2   | Low Temperature Operating                         | -20°C±2°C, 240hrs (Operation state)  | --    |
| 3   | High Temperature Storage                          | 80°C±2°C, 240hrs   | --    |
| 4   | Low Temperature Storage                           | -30°C±2°C, 240hrs  | --    |
| 5   | High Temperature and High Humidity Operation Test | 60°C±2°C, 90%, 240hrs  | --    |
| 6   | Vibration Test                                    | Total fixed amplitude: 1.5mm<br>Vibration Frequency: 10~55Hz<br>One cycle 60 seconds to 3 direction of X, Y, Z each 15 minutes.  | --    |
| 7.  | Drop Test   | To be measured after dropping from 60cm high on the concrete surface in packing state. <div style="text-align: center; margin-top: 10px;">  </div> | --    |

- Notes:
1. No dew condensation to be observed.
  2. The function test shall be conducted after 4 hours storage at the normal temperature and humidity after removed from the test chamber.
  3. Vibration test will be conducted to the product itself without putting I in a container.

