

**Product Specification**



Model: GVTQ35TPAD2R0

Rev. No.

Issued Date.

Page.

A

2014,05,05

1 / 25

Thin-Film-Transistor LCD Module

Model: GVTQ35TPAD2R0

Acceptance

**Solomon Goldentek Display Corp.**

**NO. 18 Ta-Yeh St., Ta-Fa Industrial Park, Ta-Liao  
Hsiang, Kaohsiung Hsien 831, TAIWAN , R.O.C.**

FAX: 886-7-7886800

Approved and Checked by

Approved by	Checked by		Made by



## Product Specification

	Model: GVTQ35TPAD2R0	Rev. No.	Issued Date.	Page.
		A	2014,05,05	3 / 25

## Contents

<b>1. General Description and Features</b> .....	4
1.1 Features	4
1.2 LCD Module	4
<b>2. Mechanical Information</b> .....	5
<b>3. Electrical Specifications</b> .....	6
3.1 Absolute Max. Ratings	6
3.2 Electrical Absolute Rating	7
<b>4 Electrical Characteristics</b> .....	8
4.1 TFT-LCD Module (DC Characteristics)	8
4.2 Backlight Unit	9
<b>5 Touch Screen Panel Specifications</b> .....	10
5.1 Touch Screen Panel Specifications	10
<b>6 Block Diagram</b> .....	11
TFT-LCD Module with Backlight Unit	11
<b>7 Input Terminal Pin Assignment</b> .....	12
7.1 Pin Assignment (LCD)	12
<b>8 Optical Characteristics</b> .....	14
<b>9 Basic Display Color and Gray Scale</b> .....	17
<b>10 Interface Timing</b> .....	18
10.1 Input Signal Characteristics	18
10.2 Waveform	19
10.3 Power On/Off Sequence	19
<b>11 Reliability Condition for LCD</b> .....	20
<b>12 Dimensional outlines</b> .....	21
<b>13 Incoming Inspection Standards</b> .....	22

## Product Specification

	Model: GVTQ35TPAD2R0	Rev. No.	Issued Date.	Page.
		A	2014,05,05	4 / 25

### 1. General Description and Features

GVTQ35TPAD2R0 is a TM (Transmissive) type color active matrix TFT (Thin Film Transistor) liquid crystal display (LCD) that uses amorphous silicon TFT as a switching device. This model is composed of a TFT-LCD module, a driver circuit and a back-light unit and a touch screen panel (TSP). The resolution of a 3.5" contains 320RGBx240 dots and can display up to 16.7M colors. The following table described the features of GVTQ35TPAD2R0.

#### 1.1 Features

- QVGA(320 x 240 pixels) resolution.
- Display in 16.7M colors.
- On-chip voltage generator.
- SYNC mode is supported for digital RGB input data format.
- RoHS Compliance

#### 1.2 LCD Module

Item	Specification	Unit
Screen Size	3.5 inches	Diagonal
Display Resolution	320 x RGB x 240	Dot
Dot Pitch	0.073 (H) x 0.219 (V)	mm
Active Area	70.08 (H) x 52.56 (V)	mm
Outline Dimension	76.9 (W) x 63.9 (H) x 4.35 (D)	mm
Display Mode	Normally white/Transmissive	--
Pixel Arrangement	RGB-Stripe	--
Surface Treatment	Anti-glare (AG)	--
Display Color	16.7M	--
Viewing Direction	6 o'clock (Gray Inversion)	--
Input Interface	Digital 8-bits color RGB	--
Color Gamut	NTSC 60%	--

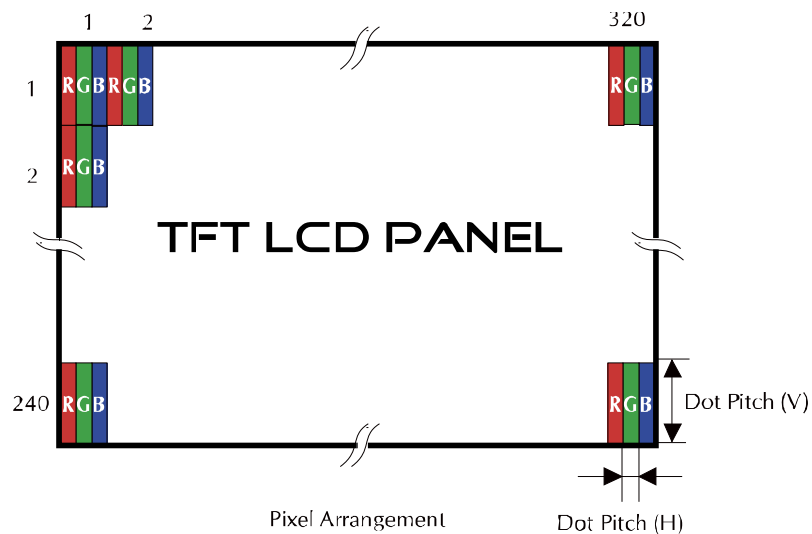

## Product Specification

	Model: GVTQ35TPAD2R0	Rev. No.	Issued Date.	Page.
		A	2014,05,05	5 / 25

### 2. Mechanical Information

Item	Min.	Typ.	Max.	Unit	Note	
Module Size	Horizontal (H)	--	76.90	--	mm	--
	Vertical (V)	--	63.90	--	mm	(1)
	Thickness (T)	--	4.35	--	mm	(2)
Weight	--	(42)	--	g	--	

Note (1) Not include FPC.

Refer to the Outline Dimension for further information.

## Product Specification

	Model: GVTQ35TPAD2R0	Rev. No.	Issued Date.	Page.
		A	2014,05,05	6 / 25

### 3. Electrical Specifications

#### 3.1 Absolute Max. Ratings

##### 3.1.1 Absolute Ratings of Environment

If the operating condition exceeds the following absolute maximum ratings, the TFT LCD module may be damaged permanently.

( $T_a=25\pm 2^\circ\text{C}$ ,  $V_{SS}=\text{GND}=0$ )

Item	Symbol	Min.	Max.	Unit	Note
Storage temperature	$T_{\text{STG}}$	-30	85	$^\circ\text{C}$	(1)
Operating temperature	$T_{\text{OPR}}$	-30	85	$^\circ\text{C}$	(1,2,3)

Note (1) 95 % RH Max. (  $40^\circ\text{C} \geq T_a$  ). Maximum wet-bulb temperature at  $39^\circ\text{C}$  or less. ( $T_a > 40^\circ\text{C}$ )  
No condensation.

Note (2) In case of below  $0^\circ$ , the response time of liquid crystal (LC) becomes slower and the color of panel becomes darker than normal one. Level of retardation depends on temperature, because of LC's character

Note (3) Only operation is guaranteed at operating temperature. Contrast, response time, another display quality are evaluated at  $+25^\circ\text{C}$ .

## Product Specification



Model: GVTQ35TPAD2R0

Rev. No.

Issued Date.

Page.

A

2014,05,05

7 / 25

### 3.2 Electrical Absolute Rating

#### 3.2.1 TFT-LCD Module

(Voltage Referenced to VSS)

Item	Symbol	Value		Unit	Condition
		Min.	Max.		
Digital Power Supply Voltage	Vcc	VSS-0.3	5.0	V	--

#### 3.2.2 Back-Light Unit

(Ta=25±2°C)

Item	Symbol	Min.	Max.	Unit	Note
Forward current	I <sub>f</sub>	--	(50)	mA	(1)
Reverse voltage	V <sub>R</sub>	--	(15)	V	(1)

Note (1) Permanent damage to the device may occur if maximum values are exceeded or reverse voltage is loaded. Functional operation should be restricted to the conditions described under normal operating conditions.

## Product Specification

	Model: GVTQ35TPAD2R0	Rev. No.	Issued Date.	Page.
		A	2014,05,05	8 / 25

### 4 Electrical Characteristics

#### 4.1 TFT-LCD Module (DC Characteristics)

Item	Symbol	Value			Unit	Note
		Min.	Typ.	Max.		
Digital Power Supply Voltage	$V_{CC}$	2.5	3.3	3.6	V	
Input High Threshold Voltage	$V_{IH}$	$0.8 V_{CC}$	-	$V_{CC}$	V	
Input Low Threshold Voltage	$V_{IL}$	0	-	$0.2 V_{CC}$	V	
Power Supply Current	$I_{CC}$	-	(15.6)	(22.0)	mA	(1)
Power Consumption	$P_L$	-	(51.48)	(72.6)	mW	(1)

Note (1) The specified power consumption is under the conditions at  $V_{CC}=3.3V$  ,  $F_V=60Hz$ , whereas a Power dissipation check pattern below is displayed.

Black Pattern / 0 Gray

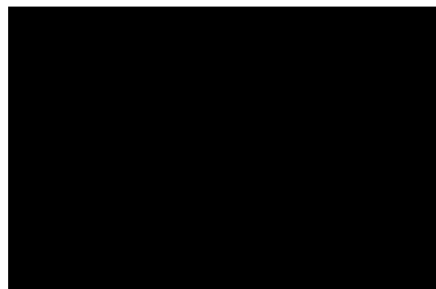

Active Area



## Product Specification

	Model: GVTQ35TPAD2R0	Rev. No.	Issued Date.	Page.
		A	2014,05,05	9 / 25

### 4.2 Backlight Unit

The back-light system is an edge-lighting type with six white LEDs (Light Emitting Diode).

(Ta=25±2°C)

Item	Symbol	Value			Unit	Condition
		Min.	Typ.	Max.		
LED Voltage	VL	8.7	9.6	10.2	V	
LED Current	IL	-	40	50	mA	
Power Consumption	P <sub>BL</sub>	-	384	510	mW	
LED Life Time(25°C)	-	20000	50000	-	hr	

Note (1) Where  $I_B = 40\text{mA}$ ,  $V_F = 9.6$ ,  $P_{BL} = V_F \times I_B$

## Product Specification

	Model: GVTQ35TPAD2R0	Rev. No.	Issued Date.	Page.
		A	2014,05,05	10 / 25

### 5 Touch Screen Panel Specifications

#### 5.1 Touch Screen Panel Specifications

##### 5.1.1 Electrical Characteristics

Item	Min.	Typ.	Max.	Unit	Note
Linearity	-1.5	-	1.5	%	Analog X and Y directions
Terminal resistance	200	-	900	$\Omega$	X (Glass side)
	200	-	900	$\Omega$	Y (Film side)
Insulation resistance	20	-	-	M $\Omega$	DC 25V
Voltage	-	5.0	7.0	V	DC
Chattering	-	-	10	ms	100k $\Omega$ pull-up

Caution (1) : Do not operate it with a thing except a polyacetal pen (tip R0.8mm or less) or a finger, especially those with hard or sharp tips such as a ball point pen or a mechanical pencil.

##### 5.1.2 Mechanical & Reliability Characteristics

Item	Min.	Typ.	Max.	Unit	Note
Activation force	-		80	g	(1)
Durability-surface scratching	Write 100,000	-	-	characters	(2)
Durability-surface pitting	1,000,000	-	-	touches	(3)
Surface hardness	3	-	-	H	JIS K5400,ASTM D3363

Note (1) Stylus pen Input : R0.8mm polyacetal pen or Finger

Note (2) Measurement for Surface area - Scratch 100,000 times straight line on the Film with a stylus change every 20,000times

- Force : 150gf
- Speed : 100mm/sec
- Stylus : R0.8 polyacetal tip

Note (2) Pit 1,000,000 times on the Film with a R8.0 silicon rubber.

- Force : Force : 250gf
- Speed : 3times/sec

## Product Specification

	Model: GVTQ35TPAD2R0	Rev. No.	Issued Date.	Page.
		A	2014,05,05	11 / 25

### 6 Block Diagram

TFT-LCD Module with Backlight Unit

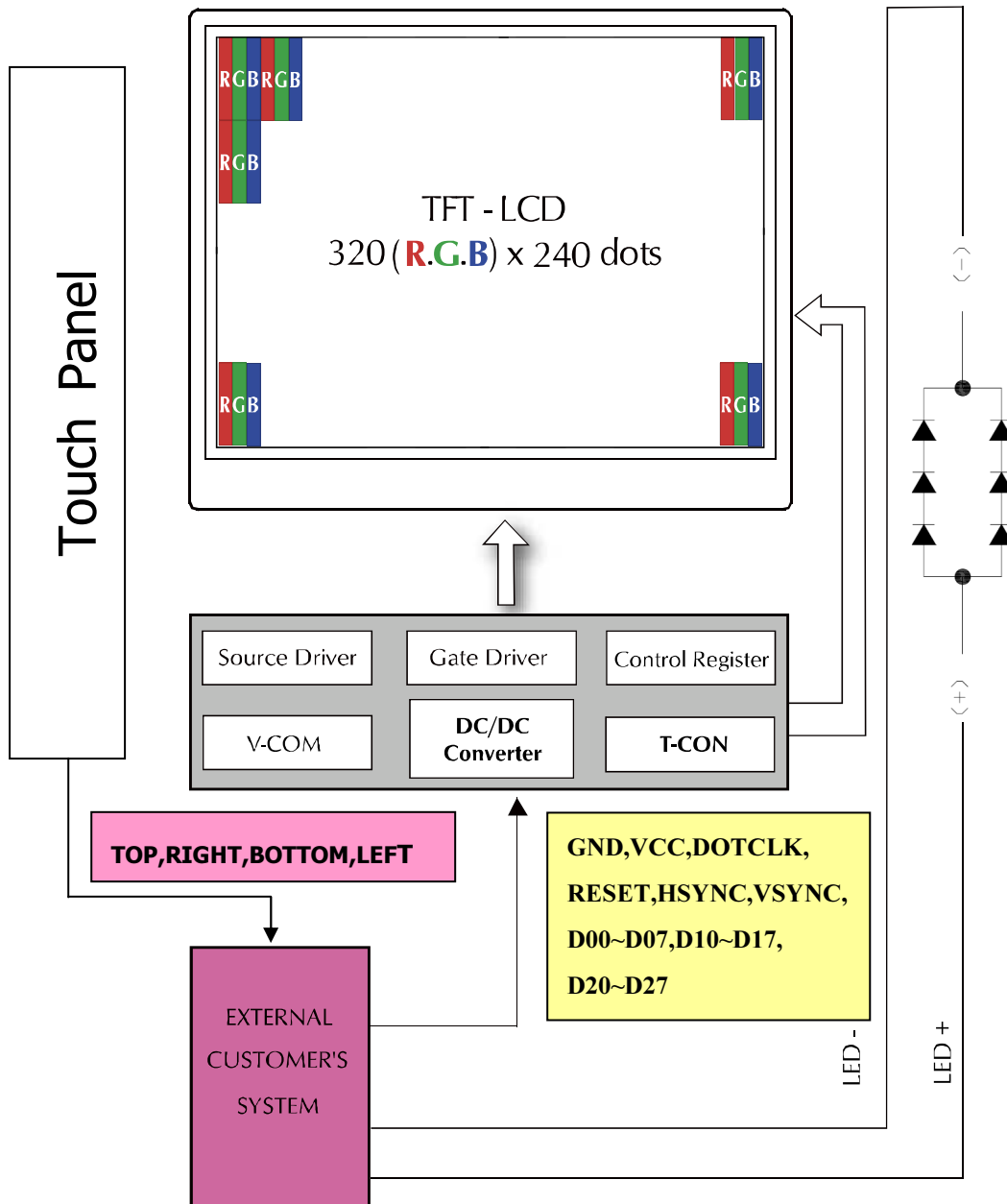

## Product Specification

	Model: GVTQ35TPAD2R0	Rev. No.	Issued Date.	Page.
		A	2014,05,05	12 / 25

### 7 Input Terminal Pin Assignment

#### 7.1 Pin Assignment (LCD)

Pin No.	Symbol	I/O	Function	Remark
1	LED_K	I	Backlight LED Ground	
2	LED_K	I	Backlight LED Ground	
3	LED_A	I	Backlight LED Power	
4	LED_A	I	Backlight LED Power	
5	N/C	I	Not Connection	
6	N/C	I	Not Connection	
7	N/C	I	Not Connection	
8	RESET	I	Hardware Reset	
9	NC	I	Not Connection	
10	NC	I	Not Connection	
11	NC	--	Not Connection	
12	D20	I	Blue Data (LSB)	
13	D21	I	Blue Data	
14	D22	I	Blue Data	
15	D23	I	Blue Data	
16	D24	I	Blue Data	
17	D25	I	Blue Data	
18	D26	I	Blue Data	
19	D27	I	Blue Data (MSB)	
20	D10	I	Green Data (LSB)	
21	D11	I	Green Data	
22	D12	I	Green Data	
23	D13	I	Green Data	
24	D14	I	Green Data	
25	D15	I	Green Data	
26	D16	I	Green Data	
27	D17	I	Green Data (MSB)	
28	D00	I	Red Data (LSB)	
29	D01	I	Red Data	
30	D02	I	Red Data	
31	D03	I	Red Data	
32	D04	I	Red Data	
33	D05	I	Red Data	

## Product Specification

	Model: GVTQ35TPAD2R0	Rev. No.	Issued Date.	Page.
		A	2014,05,05	13 / 25

34	D06	I	Red Data	
35	D07	I	Red Data (MSB)	
36	H <sub>SYNC</sub>	I	Horizontal Sync Input	
37	V <sub>SYNC</sub>	I	Vertical Sync Input	
38	D <sub>OTCLK</sub>	I	Dot Data Clock	
39	N/C	I	Not Connection	
40	N/C	I	Not Connection	
41	VCC	I	For system power supply.	
42	VCC	I	For system power supply.	
43	N/C	I	Not Connection	
44	N/C	I	Not Connection	
45	YU	I	Touch Panel Top Side	
46	XR	I	Touch Panel Right Side	
47	YD	I	Touch Panel Bottom Side	
48	XL	I	Touch Panel Left Side	
49	N/C	I	Not Connection	
50	N/C	I	Not Connection	
51	N/C	I	Not Connection	
52	N/C	I	Not Connection	
53	GND	I	Ground	
54	GND	I	Ground	

## Product Specification

	Model: GVTQ35TPAD2R0	Rev. No.	Issued Date.	Page.
		A	2014,05,05	14 / 25

### 8 Optical Characteristics

The following items are measured under stable conditions. The optical characteristics should be measured in a dark room or equivalent state with the methods shown in Note (1).

Measuring equipment: BM-5A, BM-7,

(Ta=25±2°C)

Item		Symbol	Condition	Min	Type	Max	Unit	Note	
Brightness		--	$\theta=0^\circ$ Normal Viewing Angle	(540)	(640)	--	cd/m <sup>2</sup>	--	
Response time		T <sub>R</sub>		--	15	20	ms	--	
		T <sub>F</sub>		--	35	50	ms		
Brightness uniformity		B <sub>UNI</sub>			80	-	-	%	
Contrast ratio		CR			300	450	--	--	--
Color Chromaticity (CIE1931)	Red	R <sub>X</sub>			(0.590)	(0.640)	(0.690)	--	--
		R <sub>Y</sub>			(0.294)	(0.344)	(0.394)		
	Green	G <sub>X</sub>			(0.248)	(0.298)	(0.348)	--	
		G <sub>Y</sub>			(0.532)	(0.583)	(0.633)		
	Blue	B <sub>X</sub>			(0.090)	(0.140)	(0.190)	--	
		B <sub>Y</sub>		(0.080)	(0.130)	(0.180)			
	White	W <sub>X</sub>		(0.262)	(0.312)	(0.362)	--		
		W <sub>Y</sub>		(0.299)	(0.349)	(0.399)			
Viewing Angle (6H)	Hor.	$\theta_R$	CR≥10	50	(60)	--	Degree	--	
		$\theta_L$		50	(60)	--			
	Ver.	$\phi_H$		40	(50)	--			
		$\phi_L$		50	(60)	--			

## Product Specification

	Model: GVTQ35TPAD2R0	Rev. No.	Issued Date.	Page.
		A	2014,05,05	15 / 25

a. Test equipment setup

After stabilizing and leaving the panel alone shall be warmed up for the stable operation of LCM, the measurement should be executed. Measurement should be executed in a stable, windless, and dark room. Optical specifications are measured by Topcon BM-7(fast) with a viewing angle of 2° at a distance of 50cm and normal direction.

b. Definition of response time: Tr and Tf

The response time is defined as the following figure and shall be measured by switching the input signal for "black" and "white".

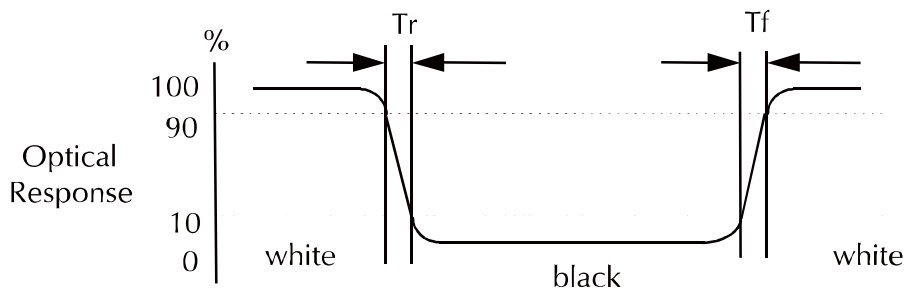

c. Definition of contrast ratio:

Brightness measured when LCD is at "white state"

$$\text{Contrast Ratio (CR)} = \frac{\text{Brightness measured when LCD is at "white state"}}{\text{Brightness measured when LCD is at "black state"}}$$

Brightness measured when LCD is at "black state"

d. Measured at the center area of the panel when all the input terminals of LCD panel are electrically opened.

## Product Specification

	Model: GVTQ35TPAD2R0	Rev. No.	Issued Date.	Page.
		A	2014,05,05	16 / 25

e. View Angle

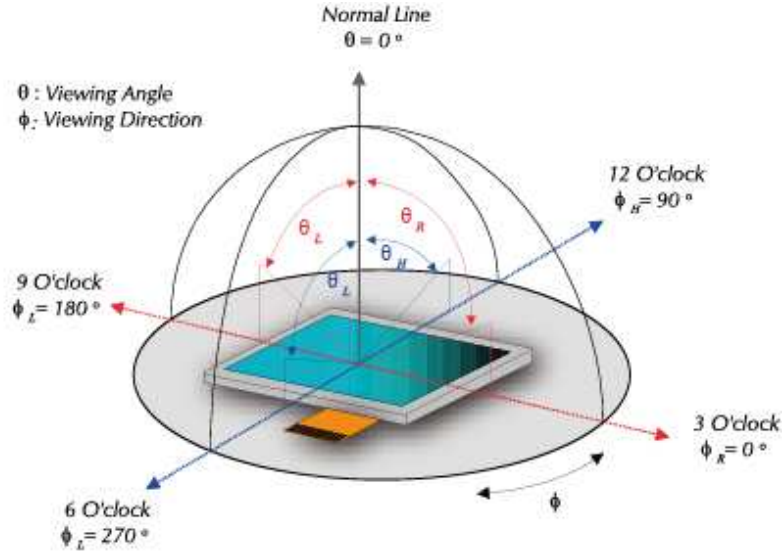

f. Definition of Luminance of White: Luminance of white at the center points

Light Source of Back-Light Unit	LED Type
---------------------------------	----------

g. Definition of White Uniformity

$$\text{White Uniformity} = \frac{\text{Min. luminance of white among 9-points}}{\text{Max. luminance of white among 9-points}}$$

h. The definition of Color Gamut -Color Chromaticity CIE 1931

Color coordinate of white & red, green, blue at center point.

Color Gamut : NTSC(%) = ( RGB Triangle Area / NTSC Triangle Area ) x 100

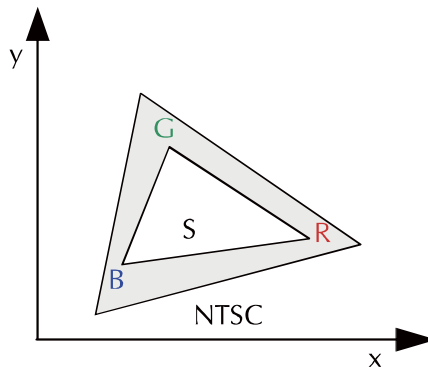



## Product Specification

	Model: GVTQ35TPAD2R0	Rev. No.	Issued Date.	Page.
		A	2014,05,05	17 / 25

### 9 Basic Display Color and Gray Scale

	Color & Gray Scale	Data Signal																							
		D07	D06	D05	D04	D03	D02	D01	D00	D17	D16	D15	D14	D13	D12	D11	D10	D27	D26	D25	D24	D23	D22	D21	D20
Basic Color	Black	0	0	0	0	0	0	0	0	0	0	0	0	0	0	0	0	0	0	0	0	0	0	0	0
	Red	1	1	1	1	1	1	1	1	0	0	0	0	0	0	0	0	0	0	0	0	0	0	0	0
	Green	0	0	0	0	0	0	0	0	1	1	1	1	1	1	1	1	0	0	0	0	0	0	0	0
	Blue	0	0	0	0	0	0	0	0	0	0	0	0	0	0	0	0	1	1	1	1	1	1	1	1
	Cyan	0	0	0	0	0	0	0	0	1	1	1	1	1	1	1	1	1	1	1	1	1	1	1	1
	Magenta	1	1	1	1	1	1	1	1	0	0	0	0	0	0	0	0	1	1	1	1	1	1	1	1
	Yellow	1	1	1	1	1	1	1	1	1	1	1	1	1	1	1	1	0	0	0	0	0	0	0	0
	White	1	1	1	1	1	1	1	1	1	1	1	1	1	1	1	1	1	1	1	1	1	1	1	1
Red	Black	0	0	0	0	0	0	0	0	0	0	0	0	0	0	0	0	0	0	0	0	0	0	0	
	Red(1)	0	0	0	0	0	0	0	1	0	0	0	0	0	0	0	0	0	0	0	0	0	0	0	
	Red(2)	0	0	0	0	0	0	1	0	0	0	0	0	0	0	0	0	0	0	0	0	0	0	0	
	:	:	:	:	:	:	:	:	:	:	:	:	:	:	:	:	:	:	:	:	:	:	:	:	
	Red(127)	0	1	1	1	1	1	1	1	0	0	0	0	0	0	0	0	0	0	0	0	0	0	0	
	:	:	:	:	:	:	:	:	:	:	:	:	:	:	:	:	:	:	:	:	:	:	:	:	:
	Red(254)	1	1	1	1	1	1	1	0	0	0	0	0	0	0	0	0	0	0	0	0	0	0	0	
	Red(255)	1	1	1	1	1	1	1	1	0	0	0	0	0	0	0	0	0	0	0	0	0	0	0	
Green	Black	0	0	0	0	0	0	0	0	0	0	0	0	0	0	0	0	0	0	0	0	0	0	0	
	Green(1)	0	0	0	0	0	0	0	0	0	0	0	0	0	0	0	1	0	0	0	0	0	0	0	
	Green(2)	0	0	0	0	0	0	0	0	0	0	0	0	0	0	1	0	0	0	0	0	0	0	0	
	:	:	:	:	:	:	:	:	:	:	:	:	:	:	:	:	:	:	:	:	:	:	:	:	
	Green(127)	0	0	0	0	0	0	0	0	0	1	1	1	1	1	1	1	0	0	0	0	0	0	0	
	:	:	:	:	:	:	:	:	:	:	:	:	:	:	:	:	:	:	:	:	:	:	:	:	
	Green(254)	0	0	0	0	0	0	0	0	1	1	1	1	1	1	1	0	0	0	0	0	0	0	0	
	Green(255)	0	0	0	0	0	0	0	0	1	1	1	1	1	1	1	1	0	0	0	0	0	0	0	
Blue	Black	0	0	0	0	0	0	0	0	0	0	0	0	0	0	0	0	0	0	0	0	0	0	0	
	Blue(1)	0	0	0	0	0	0	0	0	0	0	0	0	0	0	0	0	0	0	0	0	0	0	1	
	Blue(2)	0	0	0	0	0	0	0	0	0	0	0	0	0	0	0	0	0	0	0	0	0	0	1	
	:	:	:	:	:	:	:	:	:	:	:	:	:	:	:	:	:	:	:	:	:	:	:	:	
	Blue(127)	0	0	0	0	0	0	0	0	0	0	0	0	0	0	0	0	0	1	1	1	1	1	1	
	:	:	:	:	:	:	:	:	:	:	:	:	:	:	:	:	:	:	:	:	:	:	:	:	
	Blue(254)	0	0	0	0	0	0	0	0	0	0	0	0	0	0	0	0	1	1	1	1	1	1	0	
	Blue(255)	0	0	0	0	0	0	0	0	0	0	0	0	0	0	0	0	1	1	1	1	1	1	1	

0 : Low level voltage, 1 :High level voltage

Each basic color can be displayed in 256 gray scales from 8 bit data signals. With the combination of total 24 bit data signals, the 16,777,216-color display can be achieved on the screen.

## Product Specification

	Model: GVTQ35TPAD2R0	Rev. No.	Issued Date.	Page.
		A	2014,05,05	18 / 25

### 10 Interface Timing

#### 10.1 Input Signal Characteristics

##### 9.2.1 Digital Parallel RGB Interface (320\*240 resolution)

Item	Symbol	Min.	Typ.	Max.	Unit	
DOTCLK Frequency	fDOTCLK	-	6.5	10	MHz	
DOTCLK Period	tDOTCLK	100	154	-	ns	
Horizontal Frequency (Line)	fH	-	14.9	22.35	KHz	
Vertical Frequency (Refresh)	fV	-	60	90	Hz	
Horizontal Back Porch	tHBP	-	68	-	tDOTCLK	
Horizontal Front Porch	tHFP	-	20	-	tDOTCLK	
Horizontal Data Start Point	tHBP	-	68	-	tDOTCLK	
Horizontal Blanking Period	tHBP + tHFP	-	88	-	tDOTCLK	
Horizontal Display Area	HDISP	-	320	-	tDOTCLK	
Horizontal Cycle	Hcycle	-	408	450	tDOTCLK	
Vertical Back Porch	tVBP	-	18	-	Lines	
Vertical Front Porch	tVFP	-	4	-	Lines	
Vertical Data Start Point	tVBP	-	18	-	Lines	
Vertical Blanking Period	tVBP + tVFP	-	22	-	Lines	
Vertical Display Area	NTSC	VDISP	-	240	-	Lines
	PAL			280(PALM=0)		
				288(PALM=1)		
Vertical Cycle	NTSC	Vcycle	-	262	350	Lines
	PAL			313		

## Product Specification



Model: GVTQ35TPAD2R0

Rev. No.

Issued Date.

Page.

A

2014,05,05

19 / 25

### 10.2 Waveform

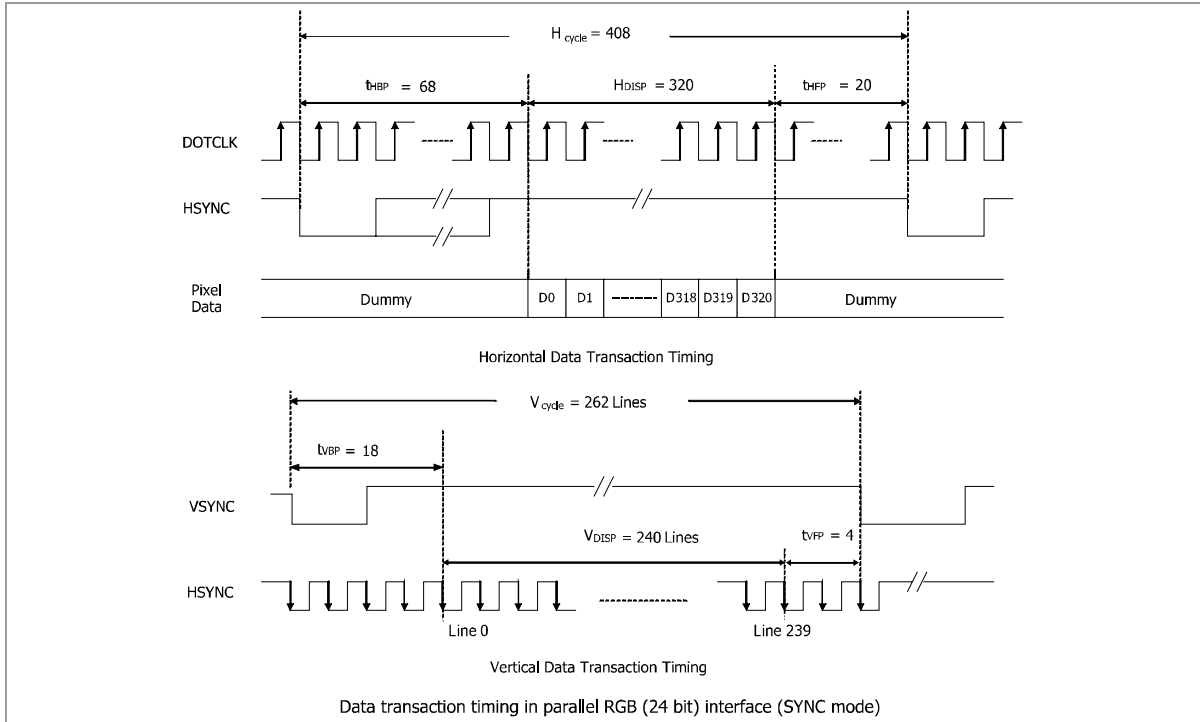

### 10.3 Power On/Off Sequence

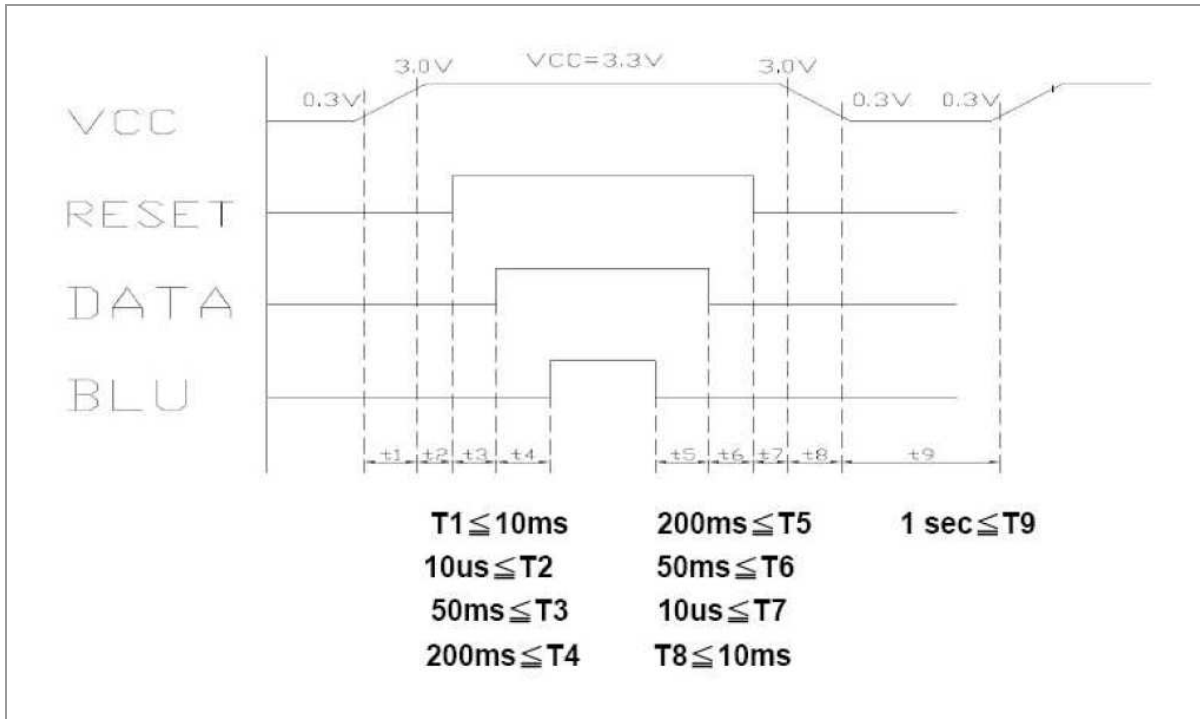

## Product Specification

	Model: GVTQ35TPAD2R0	Rev. No.	Issued Date.	Page.
		A	2014,05,05	20 / 25

### 11 Reliability Condition for LCD

No change on display and in operation under the following test condition.

Condition: Unless otherwise specified, tests will be conducted under the following condition.

Temperature: 20±5°C                      Humidity: 65±5%RH

Tests will be not conducted under functioning state.

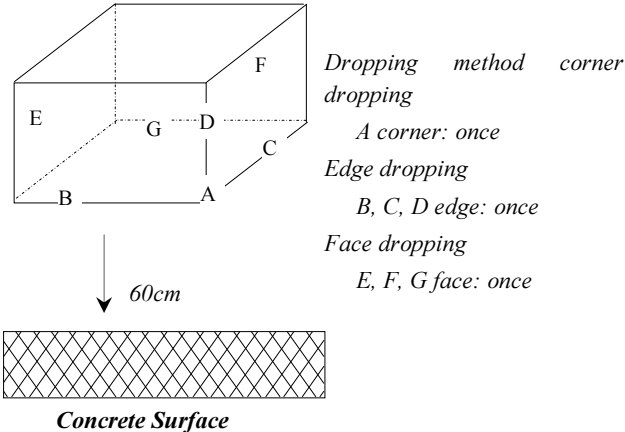
No.	Parameter	Condition	Notes
1	High Temperature Operating	85°C±2°C, 240hrs (Operation state)	--
2	Low Temperature Operating	-30°C±2°C, 240hrs (Operation state)	--
3	High Temperature Storage	85°C±2°C, 240hrs	--
4	Low Temperature Storage	-30°C±2°C, 240hrs	--
5	High Temperature and High Humidity Operation Test	60°C±2°C, 90%, 240hrs	--
6	Vibration Test	Total fixed amplitude: 1.5mm Vibration Frequency: 10~55Hz One cycle 60 seconds to 3 direction of X, Y, Z each 15 minutes.	--
7.	Drop Test	To be measured after dropping from 60cm high on the concrete surface in packing state. <div style="text-align: center; margin-top: 10px;">  <p style="margin-left: 20px;"> <i>Dropping method corner dropping</i>  <i>A corner: once</i>  <i>Edge dropping</i>  <i>B, C, D edge: once</i>  <i>Face dropping</i>  <i>E, F, G face: once</i> </p> </div>	--

- Notes:
1. No dew condensation to be observed.
  2. The function test shall be conducted after 4 hours storage at the normal temperature and humidity after removed from the test chamber.
  3. Vibration test will be conducted to the product itself without putting I in a container.



## Product Specification

	Model: GVTQ35TPAD2R0	Rev. No.	Issued Date.	Page.
		A	2014,05,05	22 / 25

### 13 Incoming Inspection Standards

#### 13.1 Inspection and Environment Conditions

##### 13.1.1 Inspection Conditions:

- (1) Inspection Distance: 35 cm±5cm
- (2) View Angle : Light-on Inspection Angle : ±5°

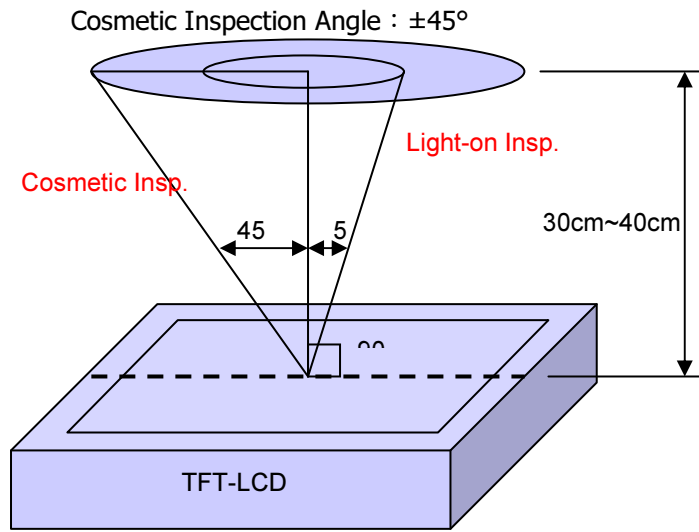

( perpendicular to LCD panel surface)

##### 13.1.2 Environment Conditions:

Ambient Temperature		23°C ±5°C
Ambient Humidity		55±10%RH
Ambient Illumination	Cosmetic Inspection	more than 600 Lux
	Functional Inspection	300~500 Lux

##### 13.1.3 Sampling Conditions:

- (1) Lot Size: Quantity of shipment lot per model
- (2) Sampling Method:

Sampling Plan		MIL-STD-105E
		Normal Inspection, Single Sampling
		Level II
AQL	Major Defect	1.0%
	Minor Defect	1.5%

- (3) The classification of Major(MA) and Minor(MI) defects is shown as 3. Inspection Criteria.

## Product Specification

	Model: GVTQ35TPAD2R0	Rev. No.	Issued Date.	Page.
		A	2014,05,05	23 / 25

### 13.1.4 Inspection Criteria

#### 13.1.4.1 Cosmetic Inspection(Panel):

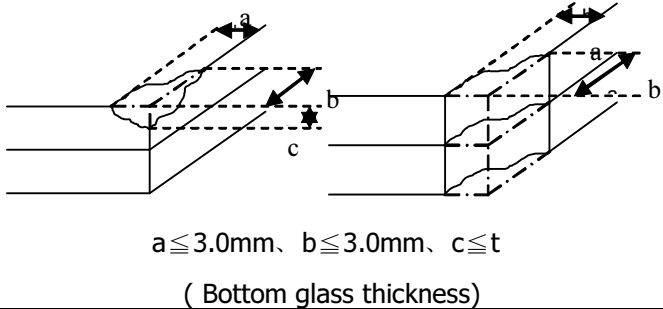
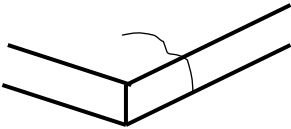
Item	Judgment Criteria	Classification
Chipping on Panel	 <p style="text-align: center;"><math>a \leq 3.0\text{mm}</math>, <math>b \leq 3.0\text{mm}</math>, <math>c \leq t</math> ( Bottom glass thickness)</p>	MA
Scratch on Panel *Note-2	$W \leq 0.05\text{mm}$ or $L < 5\text{mm}$ : Ignored $0.05\text{mm} < W \leq 0.1\text{mm}$ and $L \leq 5\text{mm}$ : $N \leq 5$ $W > 0.1\text{mm}$ or $L > 5\text{mm}$ : Not allowed	MI
Bubble or Dent on Panel *Note-3	$D \leq 0.2\text{mm}$ : Ignored $0.2\text{mm} < D \leq 0.3\text{mm}$ : $N \leq 5$ $D > 0.3\text{mm}$ : Not allowed	MI
Panel Crack	 <p style="text-align: center;">Not Allowed crack</p>	MA
Bezel Deformation	Obvious deformation is not allowed.	MI
Bezel Oxidation	Not allowed if it rusts continuously over 1 cm (It is out of warranty with rusted tin plate)	MI
Bezel Scratch	$L \leq 20\text{mm}$ , $W \leq 0.2$ , $N \leq 3$	MI
Metal Squash Dent /Flange(Front Side)	$D(W) \leq 1, L \leq 3, N \leq 3;$	MI
B/L High Voltage Wire Denudation	Not allowed	MA
Polarizer flaw or leak out resin	Defect is defined as the active area.	MI
Outline Dimension	Must in Spec, refer to related product spec.	MI

## Product Specification

	Model: GVTQ35TPAD2R0	Rev. No.	Issued Date.	Page.
		A	2014,05,05	24 / 25

### 13.1.4.2 Functional Inspection:

Item	Judgment Criteria			Classification
	Area(Note1)	I	O	
Point Defect	Bright dot	Random	2	
		2 dots adjacent	0	0
		3 dots adjacent or more	0	0
	Dark dot	Random	3	
		2 dots adjacent	0	
		3 dots adjacent or more	0	0
	Total Dot Defect		5	
	Distance	Distance between Bright and Bright dot	$L \geq 5\text{mm}$	
		Distance between Bright and Dark dot	$L \geq 5\text{mm}$	
		Distance between Dark dot	$L \geq 5\text{mm}$	
(1) It is defined as Point Defect if defect area > 0.5dot (2) It is ignored if defect area $\leq 0.5\text{dot}$ (3) Weak point defect will be defined as Bright Dot if it can be observed through ND filter 5%( Full Screen Black Inspection)				
Line Defect	Obvious vertical or horizontal line defect is not allowed.			MA
Mura	Not allowed if it can be observed through ND Filter 5 %			MI
Foreign Material in spot shape *Note-3	$D \leq 0.2\text{mm}$ : Ignored $0.2\text{mm} < D \leq 0.5\text{mm}$ : $N \leq 8$ $D > 0.5\text{mm}$ : Not allowed			MI
Foreign Material in line or spiral shape *Note-4	$W \leq 0.05\text{mm}$ or $L \leq 5\text{mm}$ : Ignored $0.05\text{mm} < W \leq 0.2\text{mm}$ and $L 1.0\text{mm} \leq 5\text{mm}$ : $N \leq 8$ $W > 0.2\text{mm}$ or $L > 5\text{mm}$ : Not allowed			MI
Display Function Abnormal	No Malfunction can be allowed			MA



## Product Specification

	Model: GVTQ35TPAD2R0	Rev. No.	Issued Date.	Page.
		A	2014,05,05	25 / 25

Note-1 : I/O Area Definition

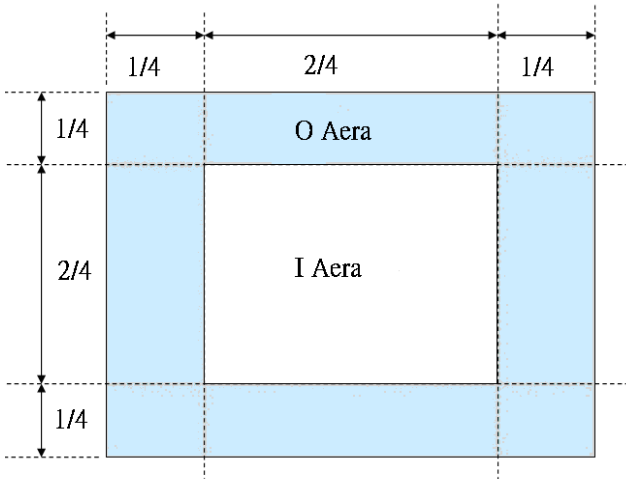

Note-2 : Polarizer Scratch

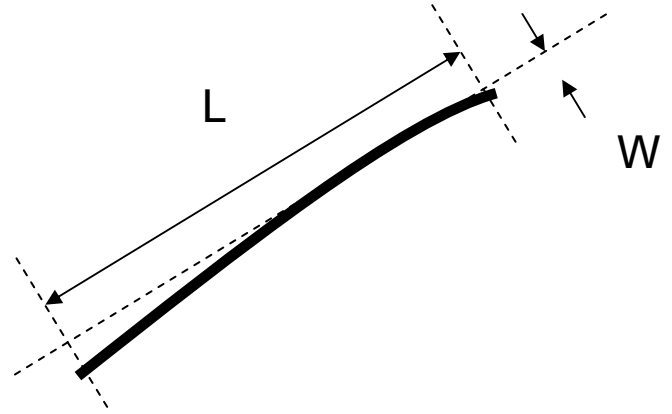

Note-3 : Spot Foreign Material  
( $W \geq L / 4$ )

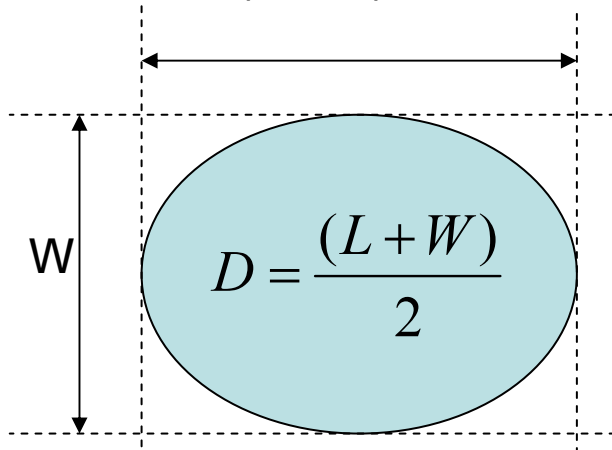

Note-4 : Line or Spiral Foreign Material  
( $W < L / 4$ )

