

Product Specification				
	Model: GVIX80MCHJ8C2	Rev. No.	Issued Date.	Page.
		A	2018/06/29	1 / 27

Product Specification For LCD Module

Model : G V I X 8 0 M C H J 8 C 2

REV : A

Display Type : TFT

CUSTOMER : STD



Acceptance

Solomon Goldentek Display Corp.

5F,42,Sing Zhong Rd,Neihu, Taipei 114 ,Taiwan, R.O.C.

TEL: 886-2-8791-9821

Approved and Checked by

Approved by	Checked by		Made by
			

Product Specification				
	Model: GVIX80MCHJ8C2	Rev. No.	Issued Date.	Page.
		A	2018/06/29	3 / 27

Contents

1. General Description and Features	4
1.1 Features	4
1.2 LCD Module	4
2. Mechanical Information	4
3. Electrical Specifications	5
3.1 Absolute Max. Ratings	5
3.2 AC Timing Characteristic of the LCD	7
4. Optical Characteristics	14
4.1 Optical characteristic of the LCD	14
5. I/O Terminal	17
5.1 LCD Pin Assignment	17
5.2 Back Light Unit	17
5.3 Block Diagram	18
6 Displayed Color and Input Data	19
7. Projected capacitive touch Screen Panel Specifications	20
7.1 Touch Panel	20
7.2 Electrical Characteristics	20
7.3 Power Sequence	21
7.4 Pin Assignments and Definitions.	21
8 Reliability Condition	22
9 Dimensional Outlines	23
10 Incoming Inspection Standards	24

Product Specification

	Model: GVIX80MCHJ8C2	Rev. No.	Issued Date.	Page.
		A	2018/06/29	4 / 27

1. General Description and Features

GVIX80MCHJ8C2 is applied to the 8 inch XGA 1024 (W) x RGB x 768 (H) dots (4:3 aspect ratio) supported TFT-LCD module and can display true 16.7M colors (8 bit/ color). The module is designed for OA, Car TV application and other electronic products which require flat panel display of digital signal interface. This module is composed of a 8" TFT-LCD panel, a driver circuit and backlight unit. The following table described the features of GVIX80MCHJ8C2

1.1 Features

- Transmissive and back-light with 27 LEDs are available.
- LVDS Receiver 6/8 bit Interface.
- LED drive circuit is built in this module to provide PWM Dimmer function
- Projected capacitive touch Screen Panel
- ROHS Compliance

1.2 LCD Module

Item	Specification	Unit
Screen Size	8.0 inches	Diagonal
Display Resolution	1024 (H) x 768 (V)	Pixel
Active Area	162.05 (H) x 121.54 (V)	mm
Outline Dimension	203 (H) x 162.5 (V) x 8.775 (T)	mm
Display Mode	Normally Black	--
Pixel Arrangement	R,G,B Vertical Stripe	--
Pixel Size	0.15825 x 0.15825	mm
Surface Treatment	Glare	
Display Color	16.7M	--
Viewing Direction	Full view angle	--
Input Interface	LVDS Receiver 6/8 bit Interface	--

2. Mechanical Information

Item	Min.	Typ.	Max.	Unit	Note	
Module Size	Horizontal (H)	202.8	203	203.2	mm	
	Vertical (V)	162.3	162.5	162.7	mm	
	Thickness (T)	8.275	8.775	9.275	mm	(1)
Weight	--	TBD	--	g	--	

Note (1) Not Include Component. Refer to the Outline Dimension Drawing as attached.

Product Specification

	Model: GVIX80MCHJ8C2	Rev. No.	Issued Date.	Page.
		A	2018/06/29	5 / 27

3. Electrical Specifications

3.1 Absolute Max. Ratings

3.1.1 Absolute Ratings of Environment

If the operating condition exceeds the following absolute maximum ratings, the TFT LCD module may be damaged permanently.

(Ta=25±2°C, V_{SS}=GND=0)

Item	Symbol	Min.	Max.	Unit	Note
Storage temperature	T _{STG}	-20	60	°C	(1)(2)
Operating temperature	T _{OPR}	-10	50	°C	(1)(2)

Note1: Background color changes slightly depending on ambient temperature. This phenomenon is reversible.

Note2: Please refer to item of RELIABILITY.

3.1.2 Electrical Absolute Maximum Ratings

3.1.2.1 TFT-LCD Module

(V_{SS}=GND=0)

Parameter	Symbol	Min.	Max.	Unit	Remark
Power supply voltage	V _{CC}	-0.3	5.0	V	

3.1.2.2 LED DRIVER Absolute Maximum Ratings

Item	Symbol	Value		Unit	Note
		Min.	Max.		
LED Driver Supply Voltage	VLED	-	15	V	(1)
LED Driver PWM	PWM	-	15	V	(1)

Note (1) Permanent damage to the device may occur if maximum values are exceeded or reverse voltage is loaded.

Product Specification

	Model: GVIX80MCHJ8C2	Rev. No.	Issued Date.	Page.
		A	2018/06/29	6 / 27

3.1.3 DC Electrical Characteristics of the TFT LCD

Item	Symbol	Value			Unit	Note
		Min.	Typ.	Max.		
Power Supply Voltage	VCC	3.0	3.3	3.6	V	-
Power Supply Current	ICC	-	TBD	TBD	mA	(1)
Differential Input High Threshold Voltage	VTH	-	-	100	mV	-
Differential Input Low Threshold Voltage	VTL	-100	-	-	mV	-

Note (1) The specified power consumption is under the conditions at VCC=3.3V, FV=60Hz, whereas a power dissipation check pattern below is displayed.

White Pattern / 255 Gray



Active Area

Product Specification

	Model: GVIX80MCHJ8C2	Rev. No.	Issued Date.	Page.
		A	2018/06/29	7 / 27

3.2 AC Timing Characteristic of the LCD

3.2.1 AC Electrical Characteristics

Parameter	Symbol	Values			Unit	Remark
		Min.	Typ.	Max.		
Clock frequency	R_{XFCLK}	20	-	71	MHz	
Input data skew margin	T_{RSKM}	500	-	-	ps	
Clock high time	T_{LVCH}	-	$4/(7 * R_{XFCLK})$	-	ns	
Clock low time	T_{LVCL}	-	$3/(7 * R_{XFCLK})$	-	ns	

Product Specification



Model: GVIX80MCHJ8C2

Rev. No.

Issued Date.

Page.

A

2018/06/29

8 / 27

3.2.2 Timing Characteristic

Input Clock and Data Timing Diagram

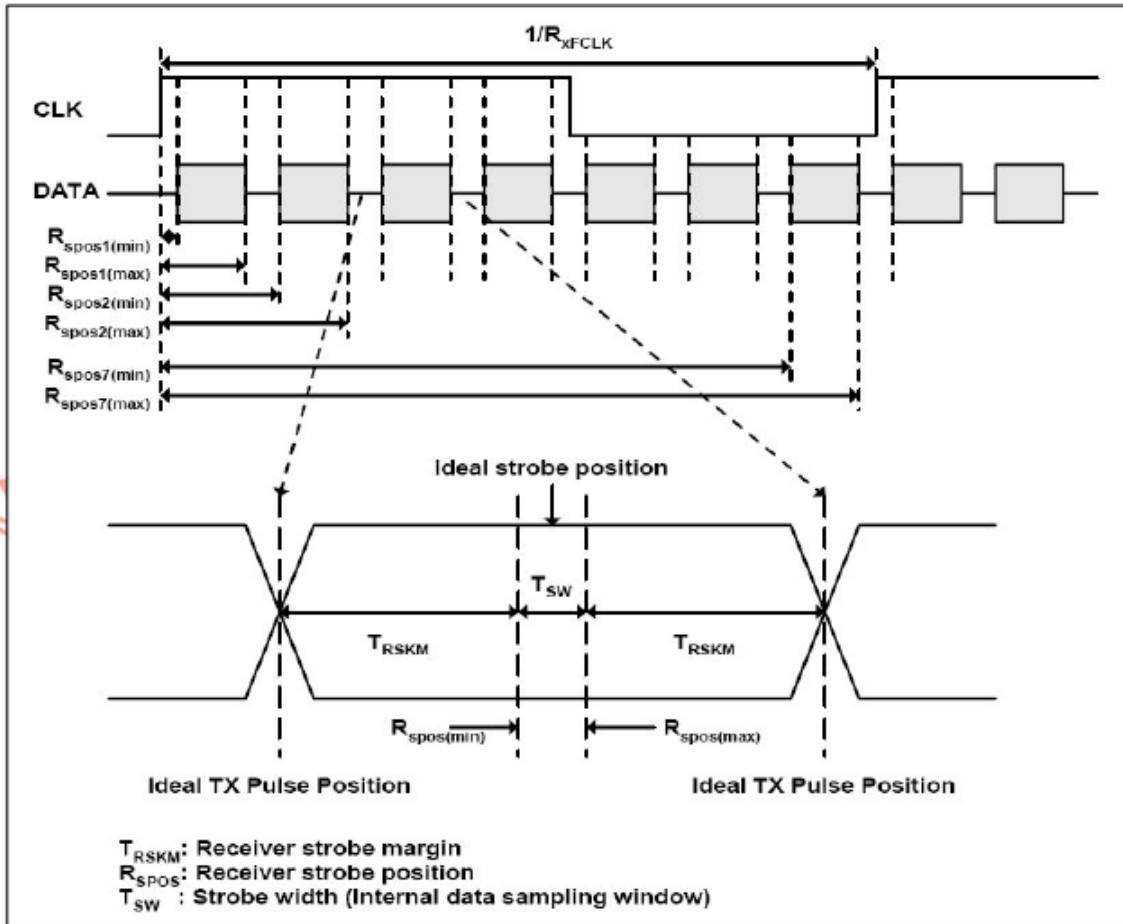

Product Specification

	Model: GVIX80MCHJ8C2	Rev. No.	Issued Date.	Page.
		A	2018/06/29	9 / 27

Parameter	Symbol	Values			Unit	Remark
		Min.	Typ.	Max.		
Differential input high Threshold voltage	R_{xVTH}	-	-	+0.1	V	
Differential input low Threshold voltage	R_{xVTL}	-0.1	-	-	V	
Input voltage range (singled-end)	R_{xVIN}	0	-	2.4	V	
Differential input common mode voltage	R_{xVCM}	$ V_{ID} /2$	-	$2.4- V_{ID} /2$	V	
Differential voltage	$ V_{ID} $	0.2	-	0.6	V	
Differential input leakage current	$R_{V_{xIIZ}}$	-10	-	+10	uA	

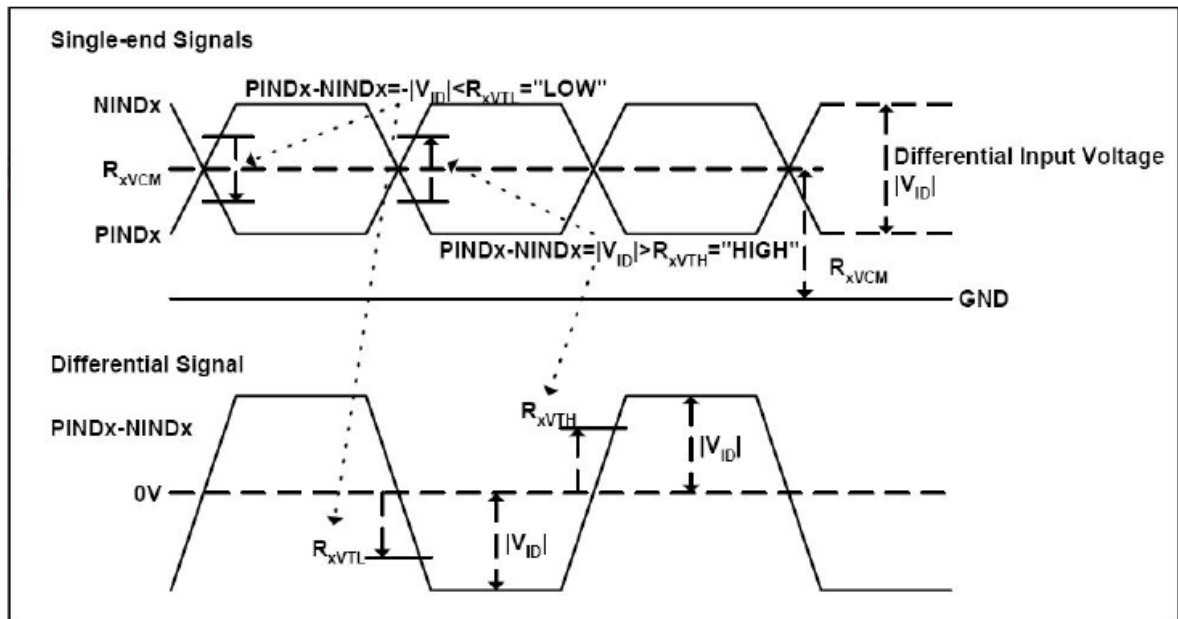

Product Specification

	Model: GVIX80MCHJ8C2	Rev. No.	Issued Date.	Page.
		A	2018/06/29	10 / 27

Timing:

Item	Symbol	Values			Unit	Remark
		Min.	Typ.	Max.		
Clock Frequency	fclk	52	65	71	MHz	Frame rate =TBD
Horizontal display area	thd	1024				
HS period time	th	1114	1344	1400	DCLK	
HS Blanking	thb+thfp	90	320	376	DCLK	
Vertical display area	tvd	768				
VS period time	tv	778	806	845	H	
VS Blanking	tvb+tvfp	10	38	77	H	

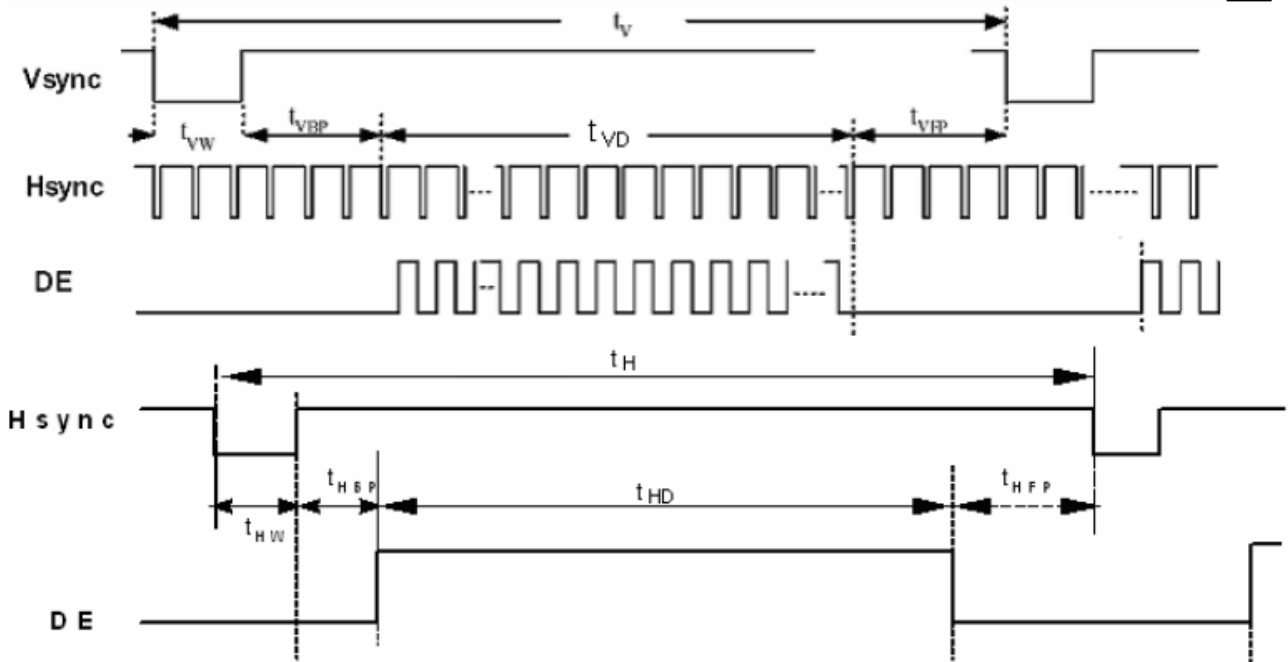

Product Specification

	Model: GVIX80MCHJ8C2	Rev. No.	Issued Date.	Page.
		A	2018/06/29	11 / 27

6bit LVDS input

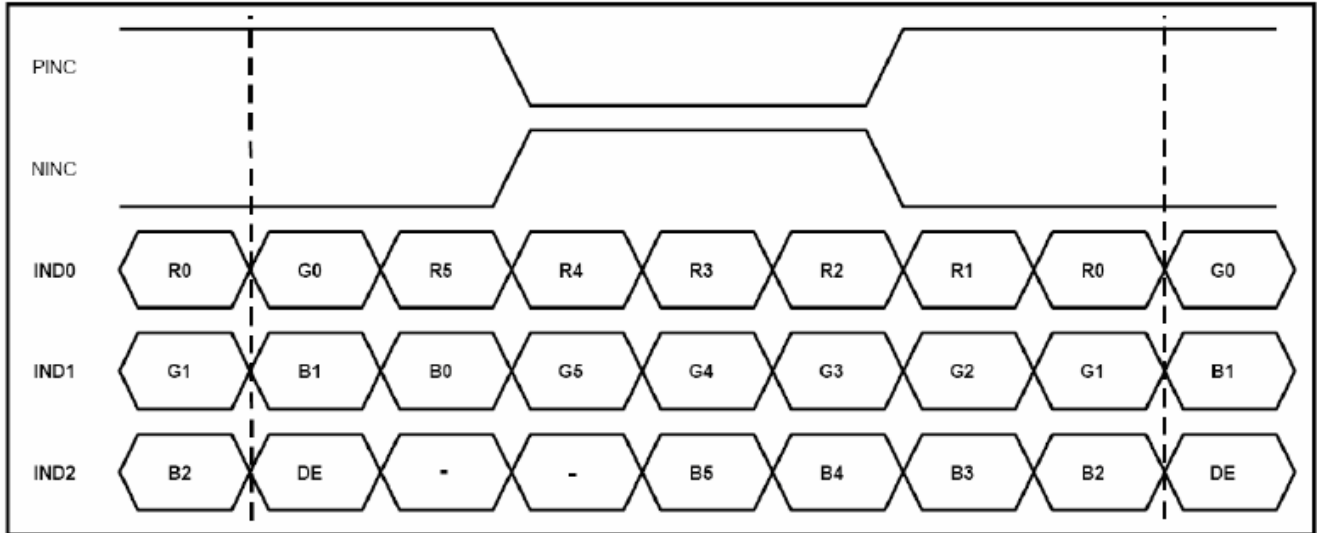

8bit LVDS input

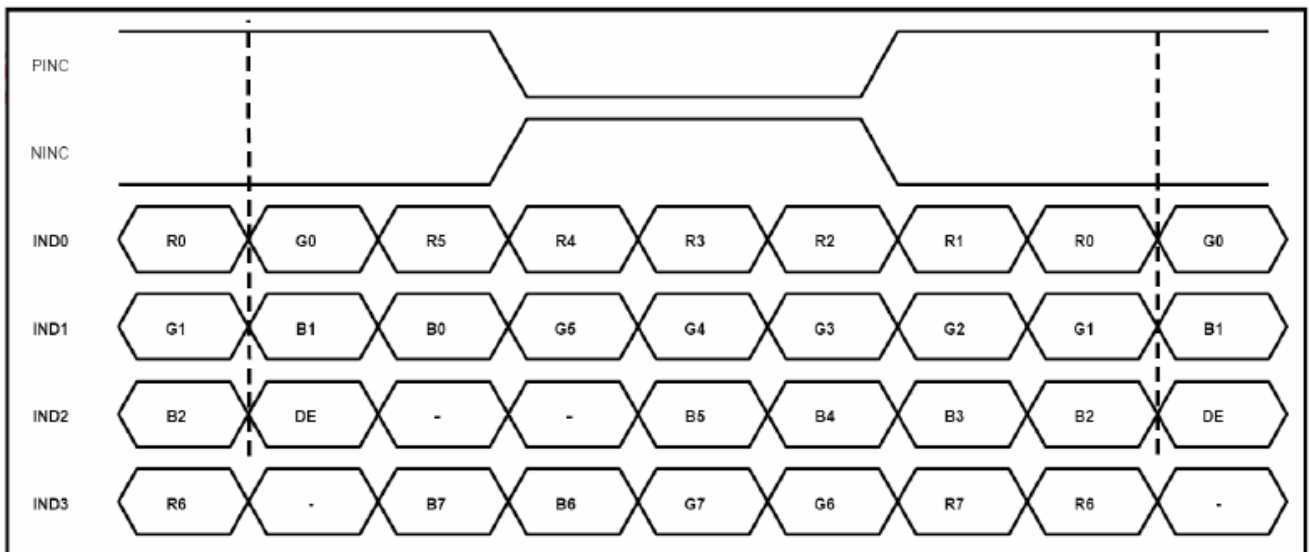

Note: Support DE timing mode only, SYNC mode not supported.

Product Specification

	Model: GVIX80MCHJ8C2	Rev. No.	Issued Date.	Page.
		A	2018/06/29	12 / 27

Power Sequence

Power on:

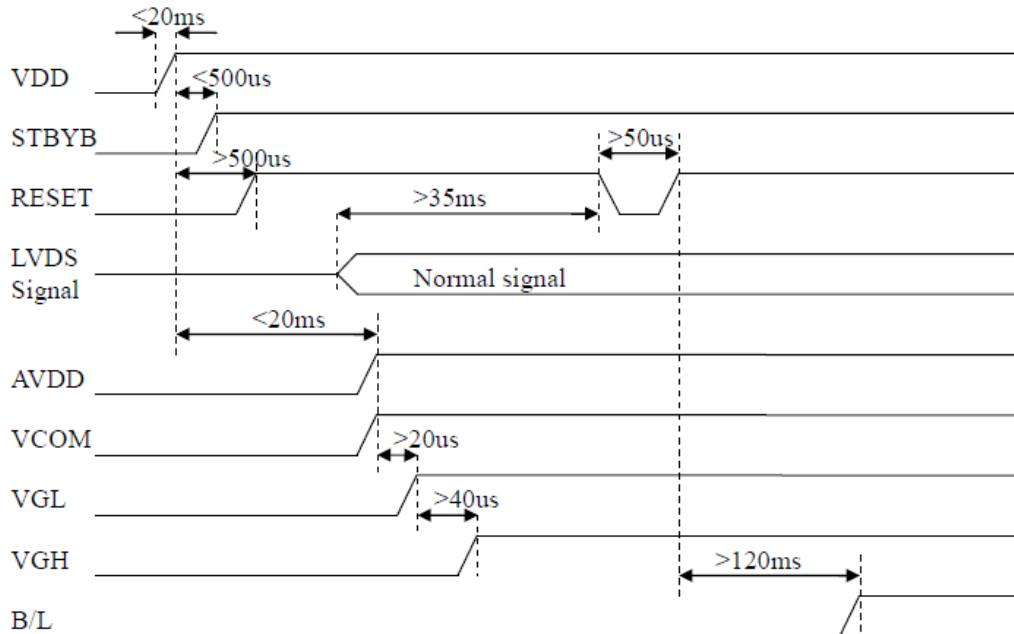

Power off:

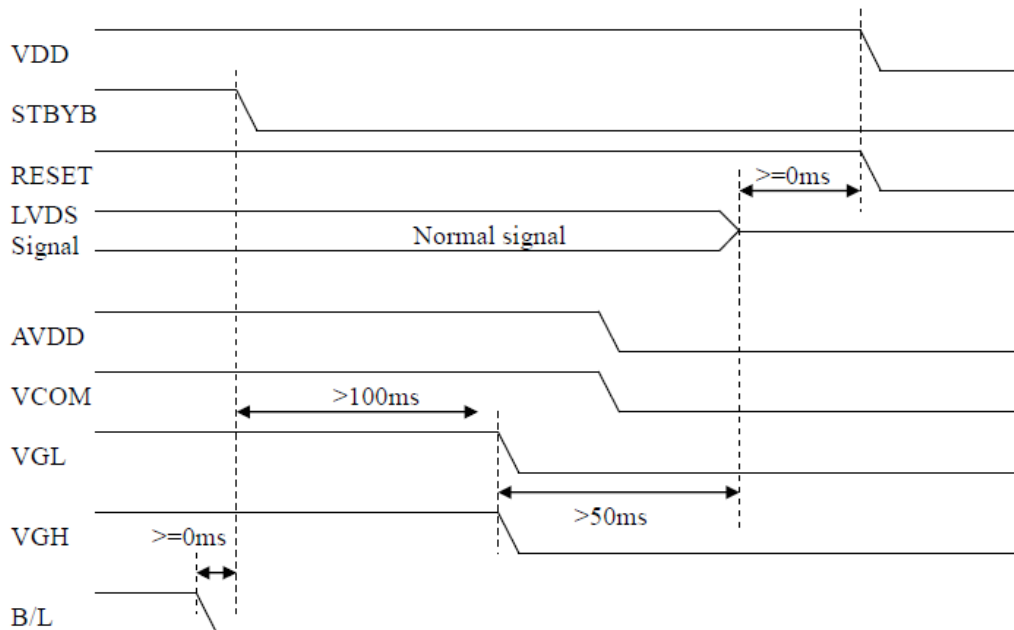

Product Specification

	Model: GVIX80MCHJ8C2	Rev. No.	Issued Date.	Page.
		A	2018/06/29	13 / 27

3.2.3 LED Driver Unit

(Ta= Room Temp)

Characteristics	Symbol	Min.	Typ.	Max.	Unit	Note
Voltage of LED Driver Unit	V _{LED(DU)}	11	12	13	V	-
Current of LED Driver Unit	I _{LED(DU)}	-	TBD	TBD	mA	I _{LED} =585mA, V _{LED} =12V
PWM Input Low Voltage	V _{PWML}	-	-	0.45	V	-
PWM Input High Voltage	V _{PWMH}	1.2	-	-	V	-
Dimmer frequency	f _{PWM}	-	120	-	Hz	-
PWM Pulse width	T _{PWMH}	3	-	-	us	-
LED life time	-	30000	50000	-	hr	(1)(2)

Note (1) : LED life time is defined as under 25±2°C , when the average brightness decrease to 50% of original brightness

Note (2) : Lifetime statement is concerning to the max backlight current of 585mA.

Product Specification

	Model: GVIX80MCHJ8C2	Rev. No.	Issued Date.	Page.
		A	2018/06/29	14 / 27

4. Optical Characteristics

4.1 Optical characteristic of the LCD

The following items are measured under stable conditions. The optical characteristics should be measured in a dark room or equivalent state with the methods.

Measuring equipment: BM-7A

Item	Symbol	Condition	Min	Type	Max	Unit	Note	
Brightness	B		760	950	--	cd/m ²		
Response time	T _r + T _f	θ=0°	--	25	50	ms	.	
						ms		
Contrast ratio	CR	At optimized viewing angle	600	800	--	--		
Luminance Uniformity	ΔL		70	75		%		
Color Chromaticity (CIE 1931)	White	θ=0° Normal Viewing Angle	Wx	0.260	0.310	0.360	--	BM-7A
			Wy	0.300	0.350	0.400		
Viewing Angle (6H)	Hor.	CR≥10	θ _R	75	85	--	Degree	
			θ _L	75	85	--		
	Ver.		θ _U	75	85	--		
			θ _D	75	85	--		
NTSC				50		%		

Product Specification

	Model: GVIX80MCHJ8C2	Rev. No.	Issued Date.	Page.
		A	2018/06/29	15 / 27

a. Test equipment setup

After stabilizing and leaving the panel alone shall be warmed up for the stable operation of LCM, the measurement should be executed. Measurement should be executed in a stable, windless, and dark room. Optical specifications are measured by Topcon BM-7(fast) with a viewing angle of 2° at a distance of 50cm and normal direction.

b. Definition of response time: Tr and Tf

The response time is defined as the following figure and shall be measured by switching the input signal for "black" and "white".

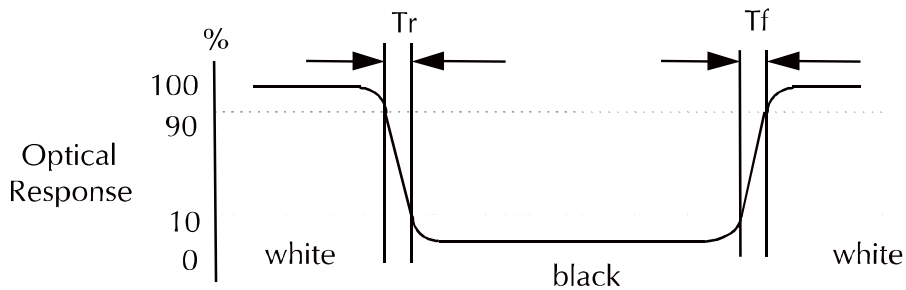

c. Definition of contrast ratio:

$$\text{Contrast Ratio (CR)} = \frac{\text{Brightness measured when LCD is at "white state"}}{\text{Brightness measured when LCD is at "black state"}}$$

d. Measured at the center area of the panel when all the input terminals of LCD panel are electrically opened.

Product Specification

	Model: GVIX80MCHJ8C2	Rev. No.	Issued Date.	Page.
		A	2018/06/29	17 / 27

5. I/O Terminal

5.1 LCD Pin Assignment

Pin No.	Symbol	I/O	Function	Remark
1	VCC	P	Power Supply +3.3V	
2	VCC	P	Power Supply +3.3V	
3	VSS	P	Ground	
4	VSS	P	Ground	
5	RIN0-	I	Negative LVDS differential data input	
6	RIN0+	I	Positive LVDS differential data input	
7	VSS	P	Ground	
8	RIN1-	I	Negative LVDS differential data input	
9	RIN1+	I	Positive LVDS differential data input	
10	VSS	P	Ground	
11	RIN2-	I	Negative LVDS differential data input	
12	RIN2+	I	Positive LVDS differential data input	
13	VSS	P	Ground	
14	RCLK-	I	Negative LVDS differential clock input	
15	RCLK+	I	Positive LVDS differential clock input	
16	VSS	P	Ground	
17	RIN3-	I	Negative LVDS differential data input	
18	RIN3+	I	Positive LVDS differential data input	
19	VSS	P	Ground	
20	VSS	P	Ground	

User Connector Part No: Hirose DF19G-20P-1H(54) or equivalent.

5.2 Back Light Unit

Pin No.	Symbol	Function	Remark
1	VLED	LED drive circuit power supply (12V)	
2	VLED	LED drive circuit power supply (12V)	
3	GND	Ground	
4	GND	Ground	
5	PWM	PWM Dimmer	
6	NC	NO CONNECTION	

User Connector Part No: JST SM06B-SHLS-TF or equivalent.

Product Specification



Model: GVIX80MCHJ8C2

Rev. No.

Issued Date.

Page.

A

2018/06/29

18 / 27

5.3 Block Diagram

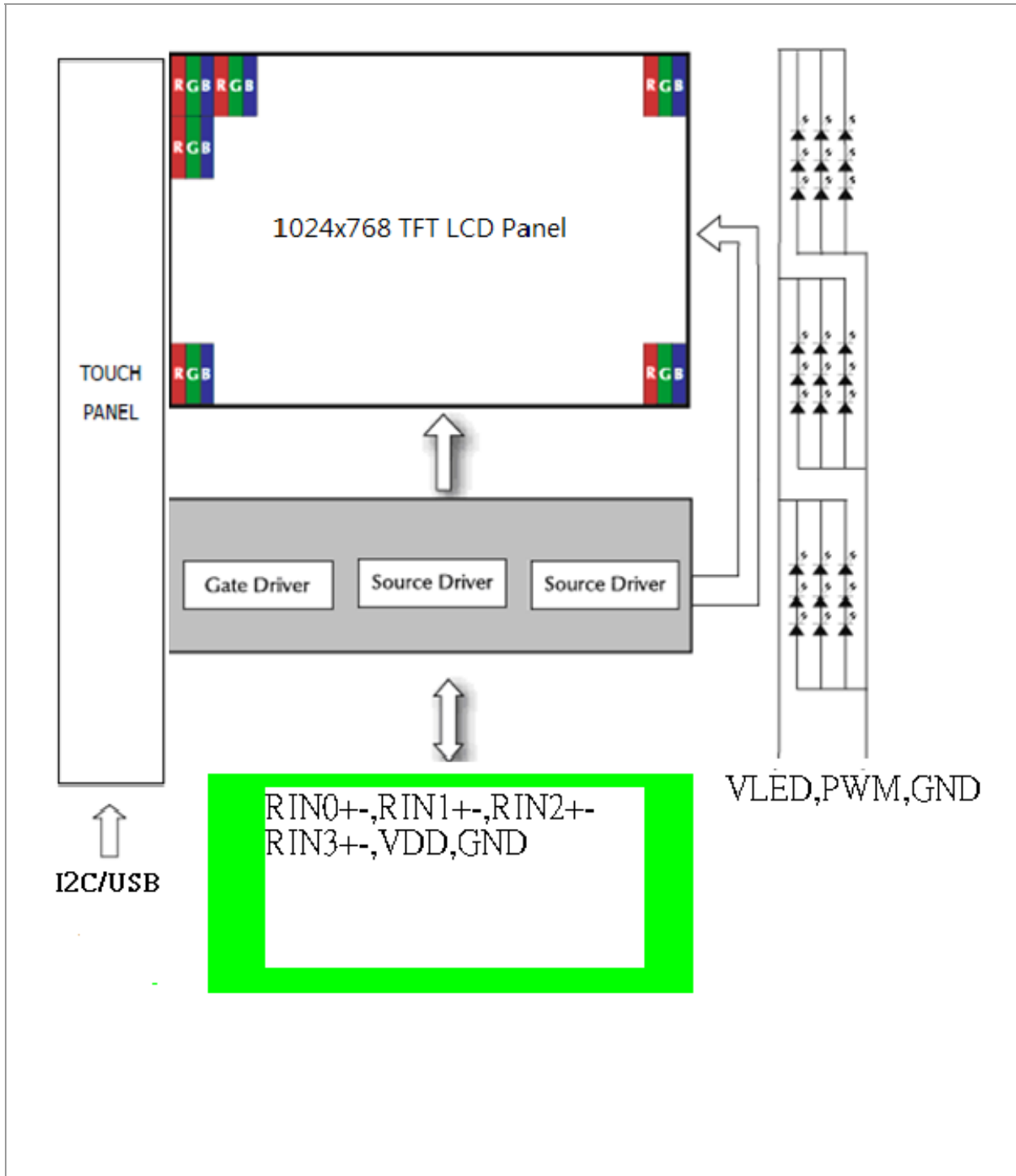

Product Specification

	Model: GVIX80MCHJ8C2	Rev. No.	Issued Date.	Page.
		A	2018/06/29	19 / 27

6 Displayed Color and Input Data

	Color & Gray Scale	Data Signal																							
		R7	R6	R5	R4	R3	R2	R1	R0	G7	G6	G5	G4	G3	G2	G1	G0	B7	B6	B5	B4	B3	B2	B1	B0
Basic Color	Black	0	0	0	0	0	0	0	0	0	0	0	0	0	0	0	0	0	0	0	0	0	0	0	
	Red	1	1	1	1	1	1	1	1	0	0	0	0	0	0	0	0	0	0	0	0	0	0	0	
	Green	0	0	0	0	0	0	0	0	1	1	1	1	1	1	1	1	0	0	0	0	0	0	0	
	Blue	0	0	0	0	0	0	0	0	0	0	0	0	0	0	0	0	1	1	1	1	1	1	1	
	Cyan	0	0	0	0	0	0	0	0	1	1	1	1	1	1	1	1	1	1	1	1	1	1	1	
	Magenta	1	1	1	1	1	1	1	1	0	0	0	0	0	0	0	0	1	1	1	1	1	1	1	
	Yellow	1	1	1	1	1	1	1	1	1	1	1	1	1	1	1	1	0	0	0	0	0	0	0	
	White	1	1	1	1	1	1	1	1	1	1	1	1	1	1	1	1	1	1	1	1	1	1	1	
Red	Black	0	0	0	0	0	0	0	0	0	0	0	0	0	0	0	0	0	0	0	0	0	0		
	Red(1)	0	0	0	0	0	0	0	1	0	0	0	0	0	0	0	0	0	0	0	0	0	0		
	Red(2)	0	0	0	0	0	0	1	0	0	0	0	0	0	0	0	0	0	0	0	0	0	0		
	:	:	:	:	:	:	:	:	:	:	:	:	:	:	:	:	:	:	:	:	:	:	:		
	Red(127)	0	1	1	1	1	1	1	1	0	0	0	0	0	0	0	0	0	0	0	0	0	0		
	:	:	:	:	:	:	:	:	:	:	:	:	:	:	:	:	:	:	:	:	:	:	:		
	Red(254)	1	1	1	1	1	1	1	0	0	0	0	0	0	0	0	0	0	0	0	0	0	0		
	Red(255)	1	1	1	1	1	1	1	1	0	0	0	0	0	0	0	0	0	0	0	0	0	0		
Green	Black	0	0	0	0	0	0	0	0	0	0	0	0	0	0	0	0	0	0	0	0	0	0		
	Green(1)	0	0	0	0	0	0	0	0	0	0	0	0	0	0	1	0	0	0	0	0	0	0		
	Green(2)	0	0	0	0	0	0	0	0	0	0	0	0	0	1	0	0	0	0	0	0	0	0		
	:	:	:	:	:	:	:	:	:	:	:	:	:	:	:	:	:	:	:	:	:	:	:		
	Green(127)	0	0	0	0	0	0	0	0	0	1	1	1	1	1	1	1	0	0	0	0	0	0		
	:	:	:	:	:	:	:	:	:	:	:	:	:	:	:	:	:	:	:	:	:	:	:		
	Green(254)	0	0	0	0	0	0	0	0	1	1	1	1	1	1	1	0	0	0	0	0	0	0		
	Green(255)	0	0	0	0	0	0	0	0	1	1	1	1	1	1	1	0	0	0	0	0	0	0		
Blue	Black	0	0	0	0	0	0	0	0	0	0	0	0	0	0	0	0	0	0	0	0	0	0		
	Blue(1)	0	0	0	0	0	0	0	0	0	0	0	0	0	0	0	0	0	0	0	0	0	1		
	Blue(2)	0	0	0	0	0	0	0	0	0	0	0	0	0	0	0	0	0	0	0	0	0	1		
	:	:	:	:	:	:	:	:	:	:	:	:	:	:	:	:	:	:	:	:	:	:	:		
	Blue(127)	0	0	0	0	0	0	0	0	0	0	0	0	0	0	0	0	1	1	1	1	1	1		
	:	:	:	:	:	:	:	:	:	:	:	:	:	:	:	:	:	:	:	:	:	:	:		
	Blue(254)	0	0	0	0	0	0	0	0	0	0	0	0	0	0	0	1	1	1	1	1	1	0		
	Blue(255)	0	0	0	0	0	0	0	0	0	0	0	0	0	0	0	1	1	1	1	1	1	1		

0 : Low level voltage, 1 :High level voltage

Each basic color can be displayed in 256 gray scales from 8 bit data signals. With the combination of total 24 bit data signals, the 16.7M color display can be achieved on the screen.

Product Specification

	Model: GVIX80MCHJ8C2	Rev. No.	Issued Date.	Page.
		A	2018/06/29	20 / 27

7. Projected capacitive touch Screen Panel Specifications

7.1 Touch Panel

Item	Specification	Unit
Screen Size	8.0 inches	Diagonal
Type	Transparent Type Projected Capacitive Touch Panel	--
Input Mode	Human's Finger/ Gloves	--
Sensor Active Area	164.4 (W) × 123.9(H)	mm
Interface	I2C/USB	--
Cover glass pencil-handness	7H	--
IC solution	IC : EXC3132	--

7.2 Electrical Characteristics

7.2.1 Absolute Maximum Ratings

Symbol	Parameter	Min	Max	Unit
VDDUSB5V-GND	Maximum Power Supply Voltage	-0.3	5.5	V
VDD3.3V-GND	Maximum Power Supply Voltage	-0.3	4	V
Vin	Input I/O Pin Voltage	GND-0.3	VDD+0.3	V
IVDD	Total current at power	-	100	mA
IGND	Total current at Gnd	-	100	mA
Vesd	Electrostatics Discharge Voltage(HBM)	4000	-	V

Product Specification

	Model: GVIX80MCHJ8C2	Rev. No.	Issued Date.	Page.
		A	2018/06/29	21 / 27

7.3 Power Sequence

7.3.1 Power-on Sequence

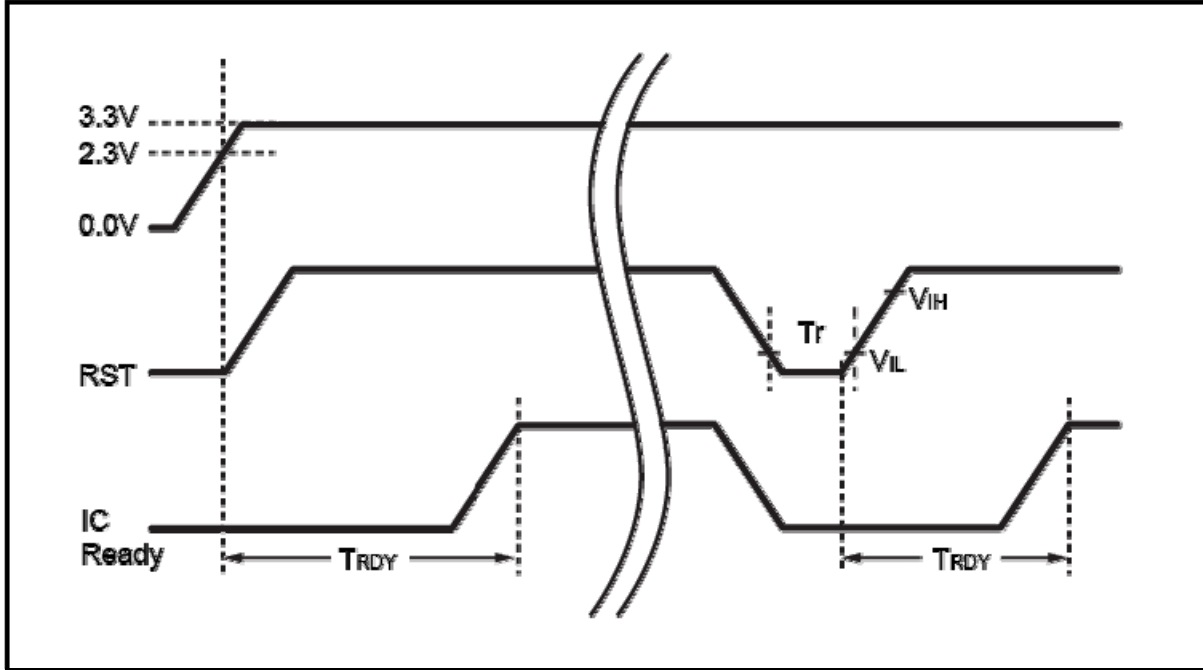

Power On Sequence Diagram

7.4 Pin Assignments and Definitions.

Item	Name	Function
1	GND	Ground
2	VDD(3.3V)	Power supply 3.3V
3	RESET	External Reset, active low
4	INT	Interrupt request to the host
5	SDA	I2C Data
6	SCL	I2C Clock
7	VDD(5V)	Power supply 5V(USB)
8	GND	Ground(USB)
9	D+	Data+(USB)
10	D-	Data-(USB)

Product Specification

	Model: GVIX80MCHJ8C2	Rev. No.	Issued Date.	Page.
		A	2018/06/29	22 / 27

8 Reliability Condition

No change on display and in operation under the following test condition.

Condition: Unless otherwise specified, tests will be conducted under the following condition.

Temperature: 20±5°C.

Humidity: 65±5%RH.

Tests will be not conducted under functioning state.

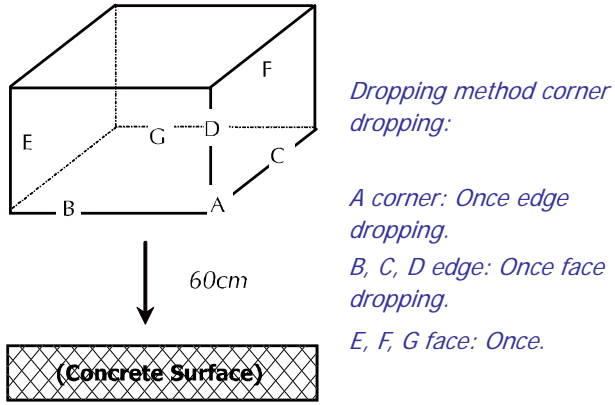
No.	Parameter	Condition	Notes
1	High Temperature Operating	50°C±2°C, 240hrs.	
2	Low Temperature Operating	-10°C±2°C, 240hrs.	1
3	High Temperature Storage	60°C±2°C, 240hrs.	2
4	Low Temperature Storage	-20°C±2°C, 240hrs.	1,2
5	High Temperature and High Humidity Operation Test	40°C±2°C, 90%, 240hrs.	1,2
6	Thermal Shock (non Operation)	-10°C/30min ~ +50°C/30min for a total 10 cycles.	1,2
6	Vibration Test	Total fixed amplitude: 1.5mm. Vibration Frequency: 10~55Hz. One cycle 60 seconds to 3 direction of X, Y, Z each 15 minutes.	3
7.	Drop Test	To be measured after dropping from 60cm high on the concrete surface in packing state. 	

Notes: 1. No dew condensation to be observed.

2. The function test shall be conducted after 4 hours storage at the normal temperature and humidity after removed from the test chamber.

3. Vibration test will be conducted to the product itself without putting I in a container.

Product Specification				
	Model: GVIX80MCHJ8C2	Rev. No.	Issued Date.	Page.
		A	2018/06/29	24 / 27

10 Incoming Inspection Standards

10.1 Inspection and Environment Conditions

10.1.1 Inspection Conditions:

- (1) Inspection Distance: 35 cm±5cm
- (2) View Angle : Light-on Inspection Angle : ±5°
Cosmetic Inspection Angle : ±45°

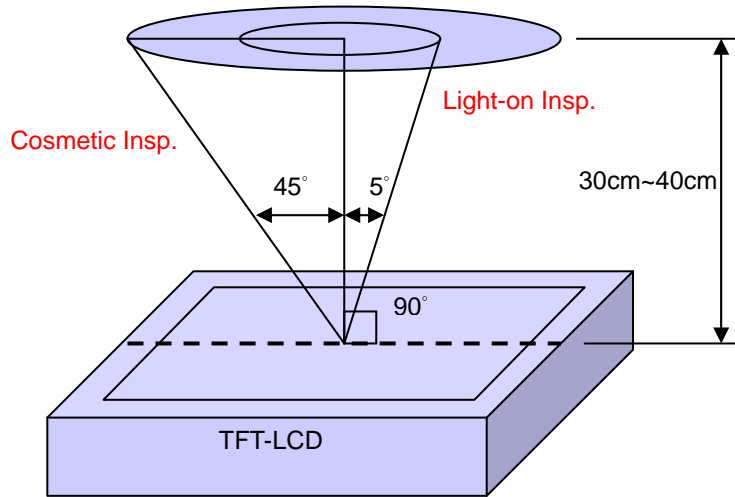

(perpendicular to LCD panel surface)

10.1.2 Environment Conditions:

Ambient Temperature		23°C ±5°C
Ambient Humidity		55±10%RH
Ambient Illumination	Cosmetic Inspection	more than 600 Lux
	Functional Inspection	300~500 Lux

10.1.3 Sampling Conditions:

- (1) Lot Size: Quantity of shipment lot per model
- (2) Sampling Method:

Sampling Plan		MIL-STD-105E
		Normal Inspection, Single Sampling
		Level II
AQL	Major Defect	1.0%
	Minor Defect	1.5%

- (3) The classification of Major(MA) and Minor(MI) defects is shown as 3. Inspection Criteria.

Product Specification

	Model: GVIX80MCHJ8C2	Rev. No.	Issued Date.	Page.
		A	2018/06/29	25 / 27

10.1.4 Inspection Criteria

10.1.4.1 Cosmetic Inspection(Panel):

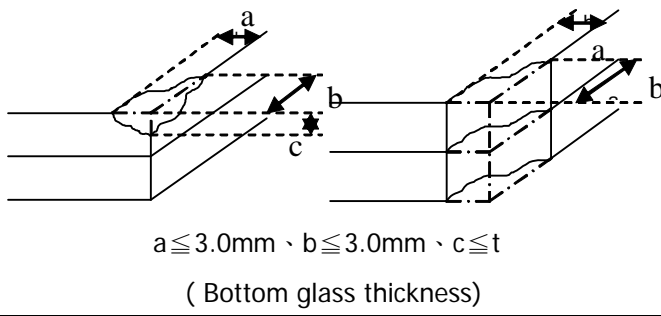
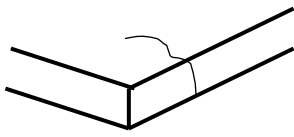
Item	Judgment Criteria	Classification
Chipping on Panel	 <p style="text-align: center;"> $a \leq 3.0\text{mm}$ · $b \leq 3.0\text{mm}$ · $c \leq t$ (Bottom glass thickness) </p>	MA
Scratch on Panel *Note-2	$W \leq 0.05\text{mm}$ or $L < 5\text{mm}$: Ignored $0.05\text{mm} < W \leq 0.1\text{mm}$ and $L \leq 5\text{mm}$: $N \leq 5$ $W > 0.1\text{mm}$ or $L > 5\text{mm}$: Not allowed	MI
Bubble or Dent on Panel *Note-3	$D \leq 0.2\text{mm}$: Ignored $0.2\text{mm} < D \leq 0.3\text{mm}$: $N \leq 5$ $D > 0.3\text{mm}$: Not allowed	MI
Panel Crack	 <p style="text-align: center;">Not Allowed crack</p>	MA
Bezel Deformation	Obvious deformation is not allowed.	MI
Bezel Oxidation	Not allowed if it rusts continuously over 1 cm (It is out of warranty with rusted tin plate)	MI
Bezel Scratch	$L \leq 20\text{mm}$, $W \leq 0.2$, $N \leq 3$	MI
Metal Squash Dent /Flange(Front Side)	$D(W) \leq 1, L \leq 3, N \leq 3$;	MI
B/L High Voltage Wire Denudation	Not allowed	MA
Polarizer flaw or leak out resin	Defect is defined as the active area.	MI
Outline Dimension	Must in Spec, refer to related product spec.	MI

Product Specification

	Model: GVIX80MCHJ8C2	Rev. No.	Issued Date.	Page.
		A	2018/06/29	26 / 27

10.1.4.2 Functional Inspection:

Item	Judgment Criteria			Classification
	Area(Note1)	I	O	
Point Defect	Bright dot	Random	2	
		2 dots adjacent	0	0
		3 dots adjacent or more	0	0
	Dark dot	Random	3	
		2 dots adjacent	1	
		3 dots adjacent or more	0	0
	Total Dot Defect		5	
	Distance	Distance between Bright and Bright dot	$L \geq 5\text{mm}$	
		Distance between Bright and Dark dot	$L \geq 5\text{mm}$	
		Distance between Dark dot	$L \geq 5\text{mm}$	
(1) It is defined as Point Defect if defect area $> 0.5\text{dot}$ (2) It is ignored if defect area $\leq 0.5\text{dot}$ (3) Weak point defect will be defined as Bright Dot if it can be observed through ND filter 5% (Full Screen Black Inspection)				
Line Defect	Obvious vertical or horizontal line defect is not allowed.			MA
Mura	Not allowed if it can be observed through ND Filter 5 %			MI
Foreign Material in spot shape *Note-3	$D \leq 0.2\text{mm}$: Ignored $0.2\text{mm} < D \leq 0.5\text{mm}$: $N \leq 8$ $D > 0.5\text{mm}$: Not allowed			MI
Foreign Material in line or spiral shape *Note-4	$W \leq 0.05\text{mm}$ or $L \leq 5\text{mm}$: Ignored $0.05\text{mm} < W \leq 0.2\text{mm}$ and $L 1.0\text{mm} \leq 5\text{mm}$: $N \leq 8$ $W > 0.2\text{mm}$ or $L > 5\text{mm}$: Not allowed			MI
Display Function Abnormal	No Malfunction can be allowed			MA

Product Specification

	Model: GVIX80MCHJ8C2	Rev. No.	Issued Date.	Page.
		A	2018/06/29	27 / 27

Note-1 : I/O Area Definition

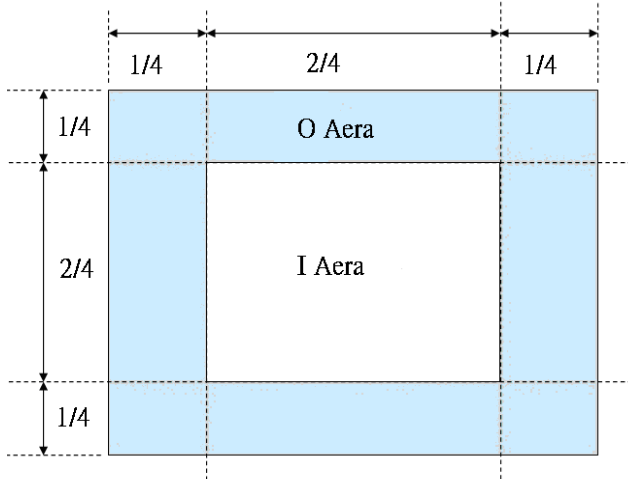

Note-2 : Polarizer Scratch

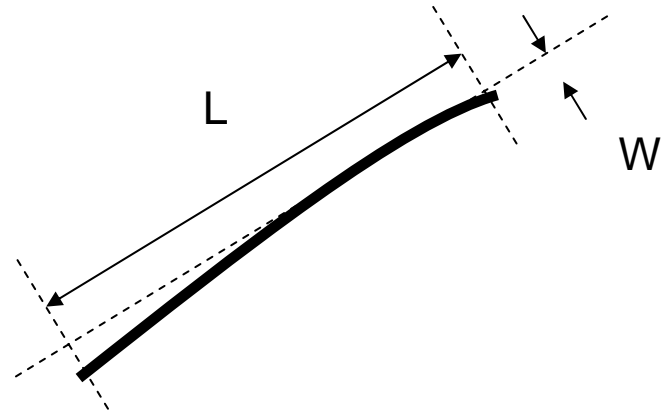

Note-3 : Spot Foreign Material
($W \geq L / 4$)

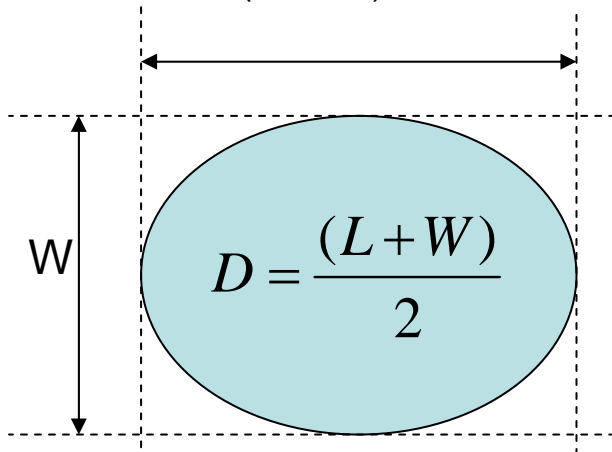

Note-4 : Line or Spiral Foreign Material
($W < L / 4$)

