

SPECIFICATION FOR APPROVAL

REF : 20080718-A

PAGE: 1

PROD. NAME	WOUND CHIP INDUCTOR	ABC'S DWG NO.	CM2520□□□□3□-□□□
		ABC'S ITEM NO.	

I . CONFIGURATION & DIMENSIONS :

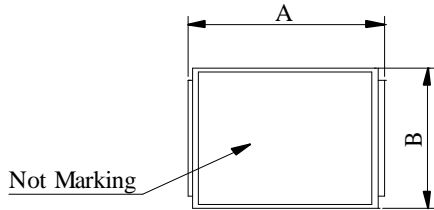

- A : 2.5±0.2 m/m
- B : 2.0±0.1 m/m
- C : 1.8±0.1 m/m
- E : 1.4±0.1 m/m
- F : 0.40 m/m

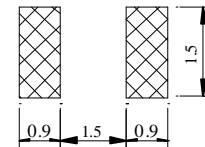
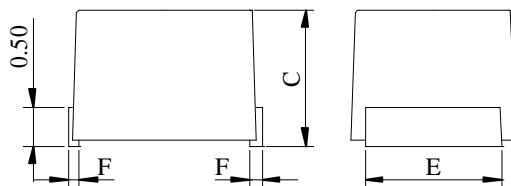

(PCB Pattern)

II . SCHEMATIC DIAGRAM :

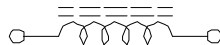

III . MATERIALS :

- a . Core : Ferrite DR core
- b . Wire : Enamelled copper wire (class F)
- c . Terminal : Cu/Sn
- d . Encapsulate : Epoxy novolac molding compound
- e . Remark : Products comply with RoHS' requirements

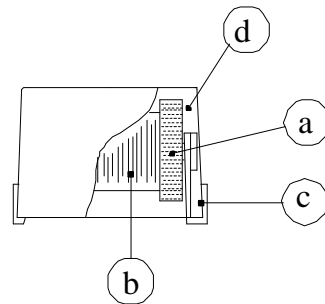

IV . GENERAL SPECIFICATION :

- a . Temp. rise : 20°C max.
- b . Ambient temp. : 80°C max.
- c . Storage temp. : -40°C ---+100°C
- d . Operating temp. : -40°C ---+85°C
- e . Terminal strength : 0.5 kg min.
- f . Rated current : Current cause
inductance drop within 10%
- g . Resistance to solder heat : 260°C.10 secs.
- h . Resistance to solvent : Per MIL-STD-202F

Peak Temp : 245°C max.
Max time above 225°C : 30sec max.
Max time above 200°C : 50sec max.

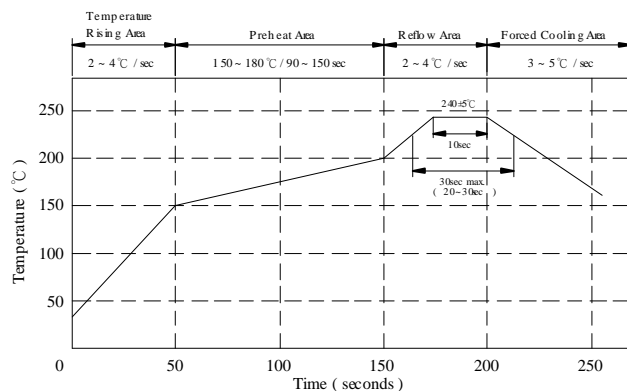

AR-001A

SPECIFICATION FOR APPROVAL

REF: 20080718-A

PAGE: 2

PROD. NAME	WOUND CHIP INDUCTOR	ABC'S DWG NO.	CM2520□□□□3□-□□□
		ABC'S ITEM NO.	

V . ELECTRICAL CHARACTERISTICS :

DWG No.	Inductance (μH)	Q min.	Test Freq (MHz)	SRF (MHz) min.	RDC (Ω) max.	IDC (mA) max
CM252010NJ3□-□□□	0.010 ±5%	15	100	2150	0.26	530
CM252012NJ3□-□□□	0.012 ±5%	15	100	2050	0.27	500
CM252015NJ3□-□□□	0.015 ±5%	15	100	2000	0.29	480
CM252018NJ3□-□□□	0.018 ±5%	15	100	1850	0.31	450
CM252022NJ3□-□□□	0.022 ±5%	15	100	1650	0.37	420
CM252027NJ3□-□□□	0.027 ±5%	15	100	1550	0.40	410
CM252033NJ3□-□□□	0.033 ±5%	20	100	1450	0.42	400
CM252039NJ3□-□□□	0.039 ±5%	20	100	1350	0.45	380
CM252047NJ3□-□□□	0.047 ±5%	20	100	1200	0.50	360
CM252056NJ3□-□□□	0.056 ±5%	20	100	1100	0.60	340
CM252068NJ3□-□□□	0.068 ±5%	20	100	1050	0.65	320
CM252082NJ3□-□□□	0.082 ±5%	20	100	900	0.75	300
CM2520R10J3□-□□□	0.100 ±5%	20	100	800	0.80	280
CM2520R12J3□-□□□	0.120 ±5%	30	25.2	700	0.30	550
CM2520R15J3□-□□□	0.150 ±5%	30	25.2	550	0.35	500
CM2520R18J3□-□□□	0.180 ±5%	30	25.2	500	0.40	460
CM2520R22J3□-□□□	0.220 ±5%	30	25.2	450	0.50	430
CM2520R27J3□-□□□	0.270 ±5%	30	25.2	425	0.55	420
CM2520R33J3□-□□□	0.330 ±5%	30	25.2	400	0.60	400
CM2520R39J3□-□□□	0.390 ±5%	30	25.2	375	0.65	375
CM2520R47J3□-□□□	0.470 ±5%	30	25.2	350	0.68	350
CM2520R56J3□-□□□	0.560 ±5%	30	25.2	325	0.75	325
CM2520R68J3□-□□□	0.680 ±5%	30	25.2	300	0.85	300
CM2520R82J3□-□□□	0.820 ±5%	30	25.2	260	1.00	260
CM25201R0J3□-□□□	1.00 ± 5%	30	7.96	245	1.10	245
CM25201R2J3□-□□□	1.20 ± 5%	30	7.96	230	1.20	230
CM25201R5J3□-□□□	1.50 ± 5%	30	7.96	182	1.30	220
CM25201R8J3□-□□□	1.80 ± 5%	30	7.96	135	1.45	210
CM25202R2J3□-□□□	2.20 ± 5%	30	7.96	105	1.55	200
CM25202R7J3□-□□□	2.70 ± 5%	30	7.96	70	1.70	195
CM25203R3J3□-□□□	3.30 ± 5%	30	7.96	55	1.90	185
CM25203R9J3□-□□□	3.90 ± 5%	30	7.96	48	2.10	180
CM25204R7J3□-□□□	4.70 ± 5%	30	7.96	43	2.30	175
CM25205R6J3□-□□□	5.60 ± 5%	25	7.96	42	2.50	170
CM25206R8J3□-□□□	6.80 ± 5%	25	7.96	39	2.70	165
CM25208R2J3□-□□□	8.20 ± 5%	25	7.96	36	3.05	160
CM2520100J3□-□□□	10.00 ± 5%	25	2.52	33	3.50	155
CM2520120J3□-□□□	12.00 ± 5%	25	2.52	30	3.80	150
CM2520150J3□-□□□	15.00 ± 5%	25	2.52	26	4.40	140
CM2520180J3□-□□□	18.00 ± 5%	25	2.52	24	4.80	130
CM2520220J3□-□□□	22.00 ± 5%	25	2.52	22	5.50	125
CM2520270J3□-□□□	27.00 ± 5%	25	2.52	21	6.30	115
CM2520330J3□-□□□	33.00 ± 5%	25	2.52	20	7.10	110
CM2520390J3□-□□□	39.00 ± 5%	20	2.52	18	9.50	90
CM2520470J3□-□□□	47.00 ± 5%	20	2.52	17	11.10	80
CM2520560J3□-□□□	56.00 ± 5%	20	2.52	16	12.10	75
CM2520680J3□-□□□	68.00 ± 5%	20	2.52	15	16.60	70
CM2520820J3□-□□□	82.00 ± 5%	20	2.52	13	19.00	66
CM2520101J3□-□□□	100.00 ± 5%	15	0.796	12	21.00	60

- 1) □ : Packaging information . . . [A]: Bulk [B]: Taping Reel
 2) " - □□□ " : Reference code

AR-001A



SPECIFICATION FOR APPROVAL

REF : 20080718-A

PAGE: 3

PROD. NAME	WOUND CHIP INDUCTOR	ABC'S DWG NO.	CM2520□□□□3□-□□□
		ABC'S ITEM NO.	

VI . PACKAGING INFORMATION :

(1) Configuration

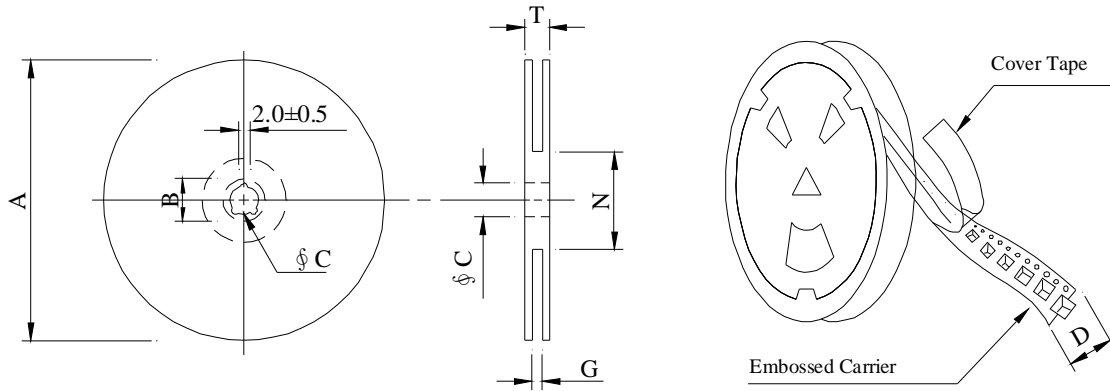

※Carrier Tape Width : D

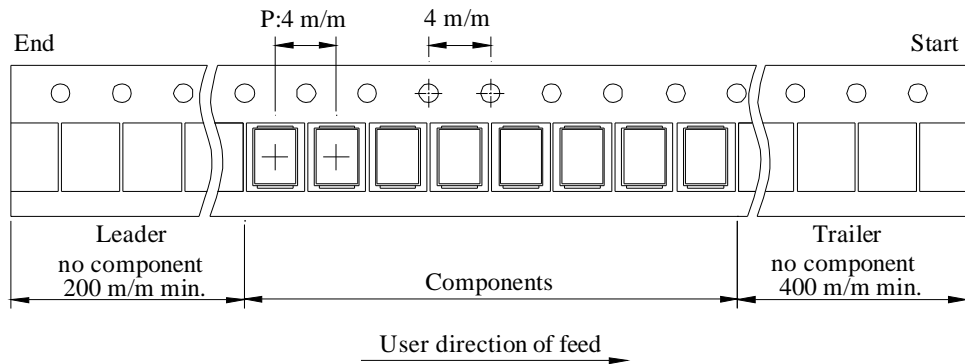

(2) Dimensions

Unit:m/m

Style	A	B	C	D	G	N	T
07 - 08	178	21±0.8	13	8	10 ⁺⁰	50 ⁻⁰	12.5

(3) Q'TY & G.W. Per package

Series	Inner : Reel			Outer : Carton		
	Q'TY (pcs)	G.W. (gw)	Style	Q'TY (pcs)	G.W. (Kg)	Size (cm)
CM2520	2,000	60	07 - 08	100,000	5.0	41 x 39 x 22

AR-001A

SPECIFICATION FOR APPROVAL

PROD. NAME	WOUND CHIP INDUCTOR	ABC'S DWG NO.	CM2520□□□□3□-□□□
		ABC'S ITEM NO.	

VII . DWGING NUMBER EXPRESSION :

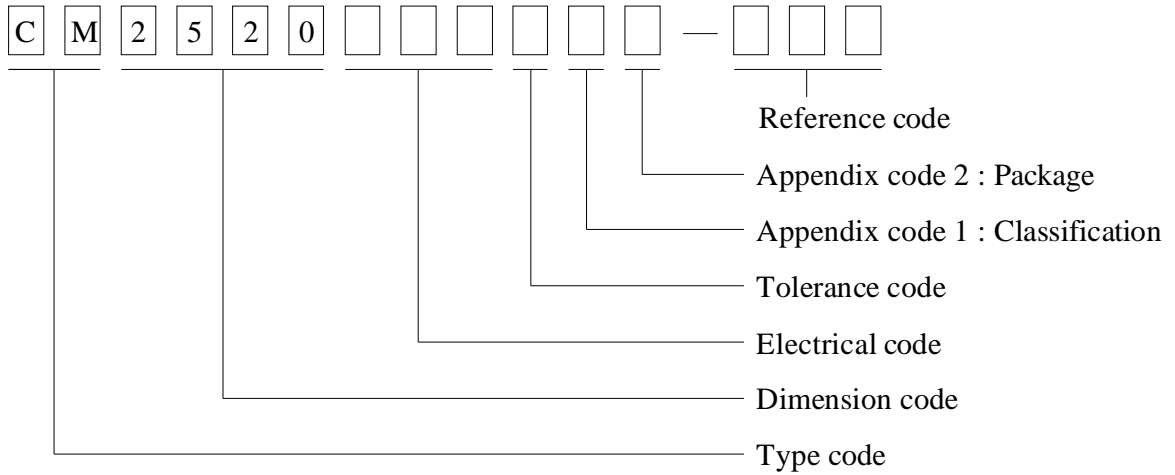

Appendix code 1 : Product Classification

- L : Lead Free Standard products comply with RoHS' requirements
- 1 ~ 9 : Lead Free Special products comply with RoHS' requirements

Appendix code 2 : Package Information

Code	Inner package	Inner package QTY	Remark
A	T.B.D.	T.B.D.	
B	T / R (Reel package)	2000 pcs	

SPECIFICATION FOR APPROVAL

REF: 20080718-A

PAGE: 5

PROD. NAME	WOUND CHIP INDUCTOR	ABC'S DWG NO.	CM2520□□□□3□-□□□
		ABC'S ITEM NO.	
VIII . RELIABILITY TEST :			
Test item	Specification	Test condition / Test method	
● Electrical performance test			
Inductance L	Refer to standard electrical characteristic list	□HP4194A with HP-16034E test fixture	
Q			
Self resonance frequency SRF		□HP4291A with HP-16093A test fixture	
DC Resistance RDC		CH-502AC	
Rated current IDC		Applied the current to coils , The Inductance change shall be less than 10% to initial value & temperature rise shall not be more than 20°C	
Temperature rise test	20°C max.	1 . Applied the allowed DC current for 10 minutes 2 . Temperature measure by digital surface thermometer	
Over load test	After test , Inductors shall be no evidence of electrical and mechanical damage	Applied 2 times of rated allowed DC current to inductor for a period of 5 minutes	
Withstanding voltage test	After tset , Inductors shall be no evidence of electrical and mechanical damage	AC voltage of 1000VAC applied between inductors terminal and coating for 5 seconds	
Insulation resistance test	1000 MΩ min .	100 VDC applied between inductor terminal and coating	
● Mechanical performance test			
Vibration test (Low frequency)	1 . Inductors shall be no evidence of electrical and mechanical damage 2 . Inductance shall not change more than±5% 3 . Q Shall not change more than ±20%	1 . Amplitude : 1.5 m/m 2 . Frequency : 10 -- 55 -- 10 Hz / 1min. 3 . Direction : X , Y , Z 4 . Duration : 2 hrs / X , Y , Z	
Shock test		Inductors shall be dropped 10 times from a height of 1m onto 3cm wooden board	
Resistance to soldering heat		Temp : 260±5°C Time : 10±1.0 sec.	

AR-001A



SPECIFICATION FOR APPROVAL

REF: 20080718-A

PAGE: 6

PROD. NAME	WOUND CHIP INDUCTOR	ABC'S DWG NO.	CM2520□□□□3□-□□□
		ABC'S ITEM NO.	
Terminal strength-pull test	Terminal shall not be loosened or ruptured	A 0.5kg load shall be applied to both Terminals in the axis direction for 1 minute .	
Solderability test	The terminal shall be at least 90% covered with solder	After fluxing , Inductor shall be dipped in a melted solder bath at 230±5°C for 5 seconds .	
Resistance to solvent test	There shall be no case deformation change in appearance or obliteration of marking	MIL-STD-202F , Method 215D	
● Climatic test			
Temperature characteristic	1 . Inductors shall be no evidence of electrical and mechanical damage 2 . Inductance shall not change more than ±10% 3 . Q shall not change more than ±20%	-25°C -- 85°C	
Humidity test		1 . Temp : 40±2°C 2 . R.H. : 90 -- 95% 3 . Time : 96±2 hours	
Cold test		1 . Temp : -25±2°C 2 . Time : 96±2 hours	
Thermal shock test		<pre> graph LR subgraph Cycle1 RT1[Room temp 15 mins] --> T1[-25±2°C 30 mins] end subgraph Cycle2 RT2[Room temp 15 mins] --> T2[85±2°C 30 mins] end </pre>	
Dry heat test		1 . Temp : 85±2°C 2 . Time : 96±2 hours	
High temperature load life test	There shall be no evidence of short or open circuiting	1 . Temp : 85±2°C 2 . Time : 1000±12 hours 3 . Load : Allowed DC current	
Humidity load life		1 . Temp : 40±2°C 2 . R.H. : 90 -- 95% 3 . Time : 1000±12 hours 4 . Load : Allowed DC current	
● Note : Unless otherwise specified , Allow the specimen to stand at room temperature for 1 hour or more but not more than 2 hours , Measure the electrical and mechanical performances			

AR-001A



SPECIFICATION FOR APPROVAL

REF : 20080718-A

PAGE: 7

PROD. NAME	WOUND CHIP INDUCTOR	ABC'S DWG NO.	CM2520□□□□3□-□□□
		ABC'S ITEM NO.	

IX . UL CARD :

OBMW2 September 8, 2000

Magnet Wire-Component

JUNG SHING WIRE CO LTD E174837

231 CHUNG CHENG RD, SEC 3 JEN-TEH HSIANG, TAINAN

HSIEN TAIWAN

Mtl Dsg	Mark Dsg	BC	Coat Typ	OC	ANSI Type	Temp Class
AIW	---	Polyamideimide	---	---	MW81-C	220
CFUEWB	---	Polyurethane	---	---	MW75C	130
EIAIW	---	Polyesterimide	Polyamideimide	---	MW35C	200
EILOCKY	---	Polyesterimide	Polyamide	---	---	180
EILOCKW	---	Polyesterimide	Modified Epoxy	---	---	200
EIW	---	Polyesterimide	---	---	---	220
EIW-2	---	Polyesterimide	---	---	MW74-C	200
FL.EILOCKY	---	Modified Polyester	Polyamide	---	---	155
LSFFW	---	Polyurethane	---	---	MW79-C	155
LSUEW	---	Polyurethane	---	---	---	130
PEW	---	Polyester	---	---	---	155
PEY	---	Polyester	Nylon	---	MW24-C	155
SF.FLW	---	Modified Polyester	---	---	MW26C	155
SF.EIW	---	Polyesterimide	---	---	MW77C	180
SF.BY@	---	Modified Polyester	Nylon	---	MW27-C	155
SF.FLY@	---	Modified Polyester	Nylon	---	MW27-C	155
SF.BLOCKBS	---	Modified Polyester	Modified Polyamide	---	---	155
SF.EILOCKY#	---	Polyesterimide	Polyamide	---	---	180
SF.EILOCKBS	---	Polyesterimide	Modified Polyamide	---	---	180
SF.BW@	---	Modified Polyester	---	---	MW26C	155
SFFW	---	Polyurethane	---	---	MW79	155

287806002 Page 1 of 2

A not-for-profit organization dedicated to public safety and committed to quality service

Mtl Dsg	Mark Dsg	BC	Coat Typ	OC	ANSI Type	Temp Class
SFFY	---	Polyurethane	Polyamide	---	MW80C	155
UEW-1	---	Polyurethane	---	---	MW2-C	105
UEW-2	---	Polyurethane	---	---	---	130
UEW-4	---	Polyurethane	---	---	MW75C	130
UEY	---	Polyurethane	Nylon	---	MW28-C	130
UEY-2	---	Polyurethane	Polyamide	---	MW28-C	130

@ - May be suffixed by LZ; # - May be suffixed by LZ, EL or LZI.
 LZ - Signifies magnd wires twisted together; EL - signifies base coated magnet wire laid parallel with top coat applied overall; LZL - signifies base coated magnet wire twisted together and covered with top coat overall.

Marking: Company name or trademarks **JSW** or 榮星電線 , material designation or marked designation on packaed or reel, and Recognized Component Mark.

See General Information Preceding These Recognitions
 For use only in equipment where the acceptability of the combination is determined by Underwriters Laboratories Inc.

287806002 Page 2 of 2

OBMW2E174837
September 8 , 2000

SPECIFICATION FOR APPROVAL

REF: 20080718-A

PAGE: 8

PROD. NAME	WOUND CHIP INDUCTOR	ABC'S DWG NO.	CM2520□□□□3□-□□□
		ABC'S ITEM NO.	

OMFZ2 March 4, 1994
 Component-Plastics
 CHANG CHUN PLASTICS CO LTD E59481 (S)
(F1-cont. from F card)

BM-21	ALL	0.79	94HB	50	50	50	—	—	—	—	—
BM-22	ALL	0.79	94HB	50	50	50	—	—	—	—	—
BM-23	ALL	0.79	94V-0	50	50	50	—	—	—	—	—
EME-1100	BK	0.84	94V-0	130	130	130	—	—	—	—	—
	BK	6.4	94V-0	130	130	130	—	—	—	—	—
EME-1200	BK	0.84	94V-0	130	130	130	—	—	—	—	—
	BK	6.4	94V-0	130	130	130	—	—	—	—	—
EME-5961C	BK	0.3	94V-0	130	130	130	—	—	—	—	—
	BK	3.1	94V-0	130	130	130	—	—	—	—	—

Reports: January 19, 1988: January 19, 1988: January 19, 1988: June 2, 1988;
 June 2, 1998; June 2, 1988.

Replaces E59481C dated February 7, 1989. (Cont. on C1 card)
 262854001 N7047 Underwriters Laboratories Inc.® D11/0018965

AR-001A

