

SPECIFICATION FOR APPROVAL

REF. :

PROD. NAME	Shielded SMD Power Inductor	ABC'S DWG NO.	DH5028□□□□F□-□□□		
		REV.	20150824-C	PAGE	1

I . Configuration and dimensions :

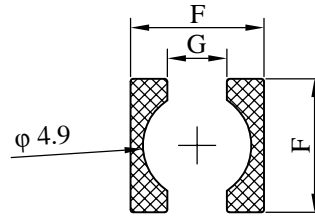
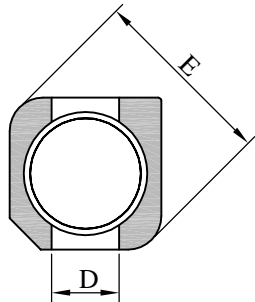
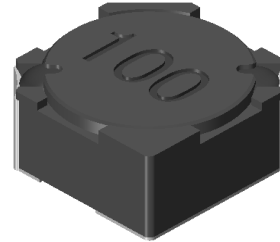
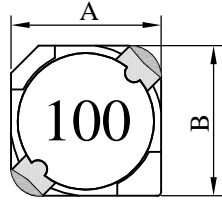

(PCB Pattern)

Unit : m/m

A	B	C	D	E	F	G
5.80 ±0.20	5.80 ±0.20	2.80 ±0.20	2.00 ref.	6.80 ref.	6.20 ref.	1.80 ref.

II . Description :

- a . Ferrite drum core construction.
- b . Magnetically shielded.
- c . Enamelled copper wire : H class
- d . Product weight : 0.350g (ref.)
- e . Moisture sensitivity Level 1
- f . Products comply with RoHS' requirements
- g . Halogen free available

III . General specification :

- a . Storage temp. : -40°C ----+125°C
- b . Operating temp. : -40°C ----+125°C
(Temp. rise included)
- c . Resistance to solder heat : 250°C .10 secs.

Peak Temp : 250°C max.
Max. Peak Temp - 5°C : 30sec max.
Max time above 217°C : 60sec~150sec max.

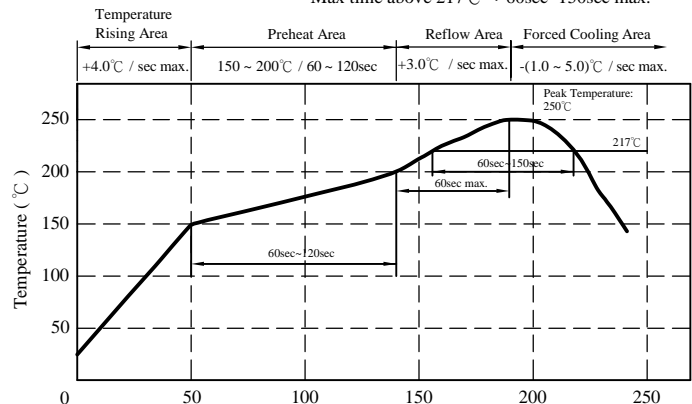

AR-001C

SPECIFICATION FOR APPROVAL

REF. :

PROD. NAME	Shielded SMD Power Inductor	ABC'S DWG NO.	DH5028□□□□F□-□□□		
		REV.	20150824-C	PAGE	2

IV . Electrical characteristics :

DWG No.	Inductance (μ H)	RDC ($m\Omega$) max.	Isat (A) typ.	Irms (A) typ.
DH50282R7YF□-□□□	2.7 \pm 30 %	30	3.00	3.10
DH50284R2YF□-□□□	4.2 \pm 30 %	35	2.70	3.00
DH50285R3YF□-□□□	5.3 \pm 30 %	40	2.50	2.85
DH50286R2YF□-□□□	6.2 \pm 30 %	45	2.00	2.65
DH50288R2YF□-□□□	8.2 \pm 30 %	55	1.80	2.45
DH5028100MF□-□□□	10.0 \pm 20 %	70	1.70	2.30
DH5028120MF□-□□□	12.0 \pm 20 %	80	1.60	2.00
DH5028150MF□-□□□	15.0 \pm 20 %	100	1.40	1.70
DH5028180MF□-□□□	18.0 \pm 20 %	110	1.20	1.50
DH5028220MF□-□□□	22.0 \pm 20 %	120	1.10	1.30
DH5028270MF□-□□□	27.0 \pm 20 %	160	1.05	1.20
DH5028330MF□-□□□	33.0 \pm 20 %	190	0.95	1.10
DH5028390MF□-□□□	39.0 \pm 20 %	210	0.90	1.00
DH5028470MF□-□□□	47.0 \pm 20 %	250	0.80	0.90
DH5028560MF□-□□□	56.0 \pm 20 %	300	0.70	0.85
DH5028680MF□-□□□	68.0 \pm 20 %	350	0.65	0.80
DH5028820MF□-□□□	82.0 \pm 20 %	430	0.55	0.65
DH5028101MF□-□□□	100.0 \pm 20 %	480	0.50	0.60
DH5028151MF□-□□□	150.0 \pm 20 %	900	0.40	0.50
DH5028221MF□-□□□	220.0 \pm 20 %	1250	0.35	0.40
DH5028331MF□-□□□	330.0 \pm 20 %	2000	0.25	0.25
DH5028681MF□-□□□	680.0 \pm 20 %	4300	0.20	0.20

- 1). □ : Packaging information : □ Code
- 2). "-□□□" : Reference code
- 3). Electrical specifications at 25°C
- 4). Inductance Test Condition. : 100kHz / 0.1V
- 5). Irms base on Temp. rise 40°C typ.
- 6). Isat base on $\Delta L/L0A = 35\%$ typ.

AR-001C

SPECIFICATION FOR APPROVAL

REF. :

PROD. NAME	Shielded SMD Power Inductor	ABC'S DWG NO.	DH5028□□□□F□-□□□		
		REV.	20150824-C	PAGE	3

V . Curve :

DH50282R7YF□

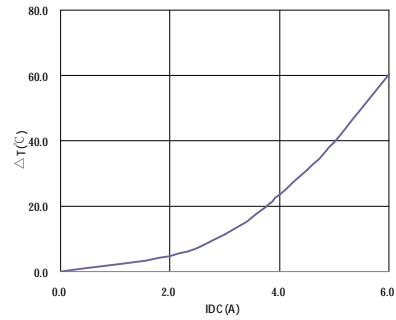
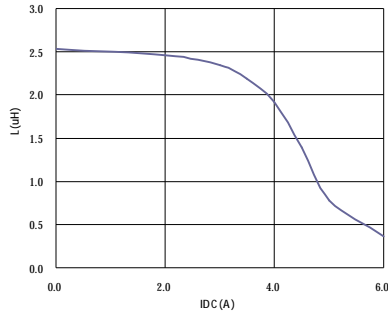

DH5028100MF□

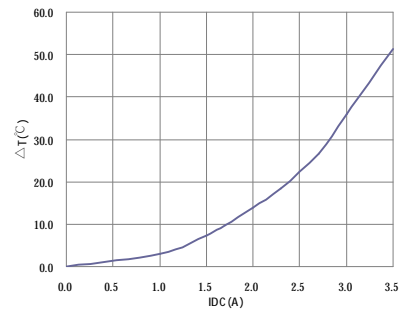
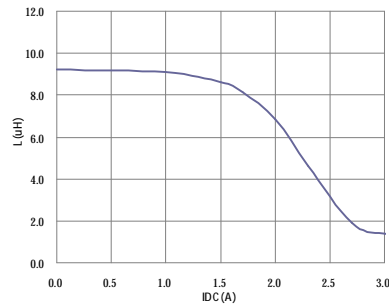

DH5028470MF□

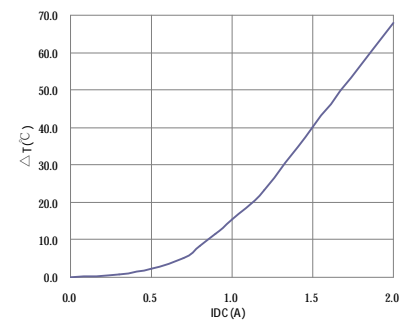
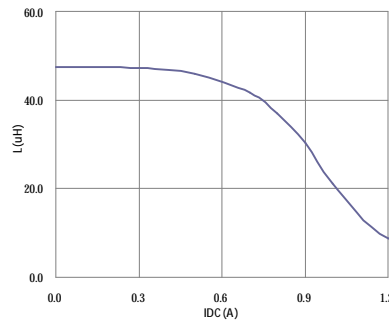

DH5028331MF□

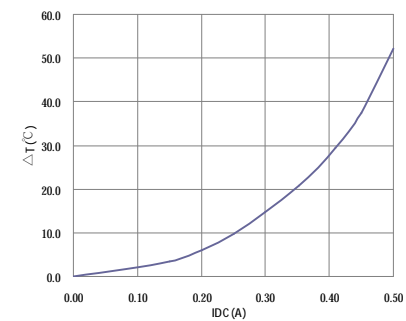
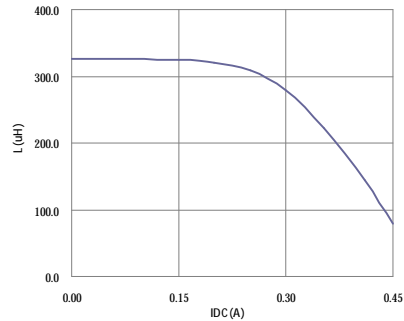

AR-001C

SPECIFICATION FOR APPROVAL

REF. :

PROD. NAME	Shielded SMD Power Inductor	ABC'S DWG NO.		DH5028□□□□F□-□□□	
		REV.	20150824-C	PAGE	4

VI . Packaging information :

(1) Configuration

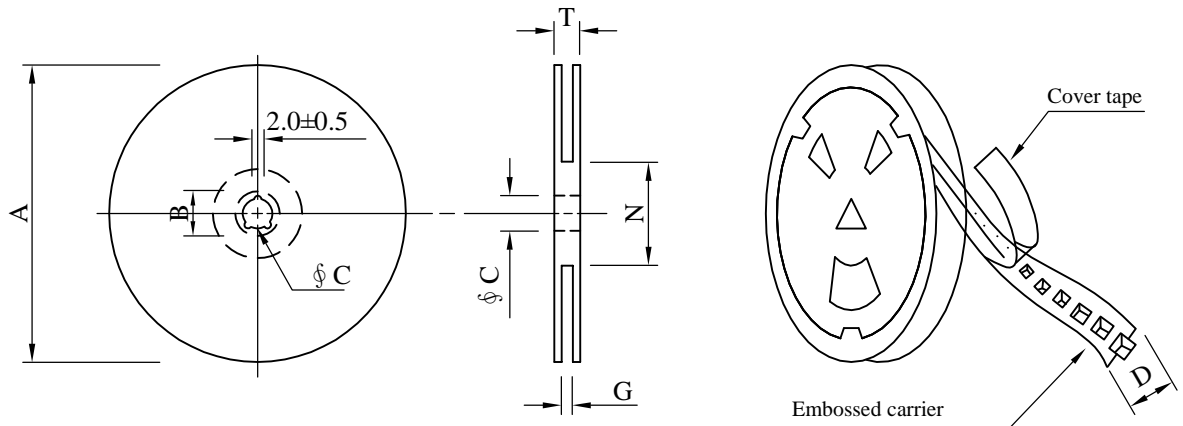

※Carrier tape width : D

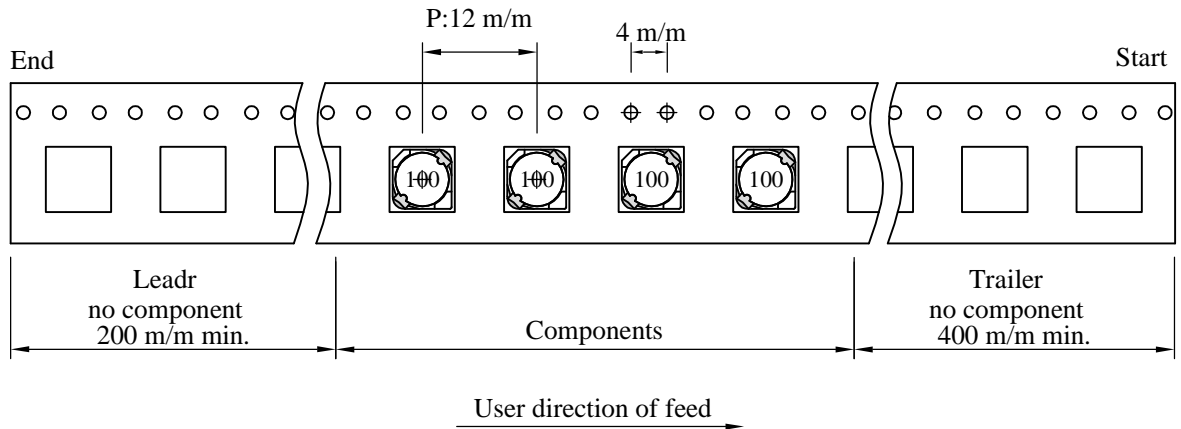

(2) Dimensions

Unit:m/m

Style	A	B	C	D	G	N	T
07 - 16	178	21±0.8	13	16	18 ⁺⁰	50 ⁻⁰	20.5
13 - 16	330	21±0.8	13±0.5	16	18 ⁺⁰	50 ⁻⁰	22.4

(3) Q'TY & G.W. Per package

Code	Inner : Reel			Outer : Carton		
	Q'TY (pcs)	G.W. (gw)	Style	Q'TY (pcs)	G.W. (Kg)	Size (cm)
B	400	260	07 - 16	12,000	9.1	42 x 41 x 24
C	1,500	940	13 - 16	9,000	6.9	38 x 37 x 22

AR-001C

SPECIFICATION FOR APPROVAL

REF. :

PROD. NAME	Shielded SMD Power Inductor	ABC'S DWG NO.	DH5028□□□□F□-□□□		
		REV.	20150824-C	PAGE	5

VII . Reliability test :

Item	Reference documents	Test Condition	Test Specification
1.High Temperature Exposure	MIL-STD-202 Method 108	1.Temperature: 125±2℃ 2.Time:96±2 hours.	1.No mechanical or electrical damage. 2.Inductance shall not change more than ±20%.
2.Temperature Cycling	JESD22-A 104	1.Temperature: -40℃ ~ +125℃ 2.Number of cycle:100 cycle 3.Dwell time:30 minutes	1.No mechanical or electrical damage. 2.Inductance shall not change more than ±20%.
3.Biased Humidity Test	MIL-STD-202 Method 103	1.Temperature : 85±2 ℃ 2.Humidity: 85% RH. 3.Time:96±2 Hours	1.No mechanical or electrical damage. 2.Inductance shall not change more than ±20%.
4.Operational Life	JESD22-A 108	1.Temperature: 125℃ (Temp. rise included) 2.Time:96±2 hours. 3.Rated current	1.No mechanical or electrical damage. 2.Inductance shall not change more than ±20%.
5.External Visual	JESD22-B 101 & MIL-STD-883 Method 2009	Inspect product constructions, marking and workmanship.	1.No pollution on the surface of products. 2.Clear marking. 3.No crack.
6.Physical Dimensions	JESD22-B 100	Verify physical dimensions to the applicable product detail specification.	Per product specification standard
7.Resistance to solvents	MIL-STD-202 Method 215	Immerse into solvent for 3±0.5 minutes & brush 10 times for 3 cycles.	1.No body change in appearance. 2.No marking blurred. 3.Inductance shall not change more than ±20%.
8.Vibration Test	MIL-STD-202 Method 204	1.Frequency and Amplitued : 10-2000-10 Hz, 1.5 mm. 2.Direction:X, Y, Z 3.Test duration:2 hours for each direction, 6 hours in total.	1.No mechanical or electrical damage. 2.Inductance shall not change more than ±20%.
9.Resistance To Soldering Heat Test	MIL-STD-202 Method 210 & J-STD020D.1	1.Highest temperature : 250±5℃. 2.Time (temp. ≥ 217℃) : 60~150 Second. 3.IR reflow times : 3 times.	1.No mechanical or electrical damage. 2.Inductance shall not change more than ±20%.
10.Saturation Current	JIS C 6436 & User SPEC.	1.Applied rated current for 5 second. 2.Saturation current	Inductance shall not drop more than 35% typ.
11.Over load	JIS C 6436 & User SPEC.	1.Applied one and half rated current for a period of 5 minutes. 2.Rated current	No electrical or mechanical damage
12.Temperature Rise Current	JIS C 6436 & User SPEC.	1.Applied rated current for 10 minutes. 2.Temperature measure by digital surface thermometer. 3.Irms current	Surface temperature rise is less than 40℃ typ.
13.Solderability Test	J-STD-002 & JESD22-B 102	1.Baking in pre-testing : 150±5℃ / 16Hours±30 min. 2.Peak temperature : 240±5℃ 3.Time (temp. ≥ 217℃) : 60~150 second. 4.IR reflow times : 1 times.	More than 95% soldering coverage min on terminations.
14.Electrical Characteriazation	MIL-STD-202 Method 304 & User SPEC.	1.Operating temperature : -40℃~125℃ 2.Room temperature : 25℃.	1.No mechanical or electrical damage. 2.Inductance shall not change more than ±20%.
15.Drop	CNS-C6354 & GB/T 2423.8	1.Products shall be mounted on SPEC. PCB and dropped down from a height of 1m 2.Drop total time : 6 time (Every side of sample drop 2 time)	1. Adhesion on PCB shall be enough. 2. Product appearance shall not break. 3. No electrical damage.
16.Terminal Strength Test	IEC 60068-2-21	1.Apply push force to samples mounted on PCB. 2.Force of 1.8 kg for 60±1 seconds.	After test, inductors shall be no mechanical damage.

AR-001C