

SPECIFICATION FOR APPROVAL

REF. :

PROD. NAME	Shielded SMD Power Inductor	ABC'S DWG NO.	HC0415□□□□S□-□□□		
		REV.	20171124-A	PAGE	1

I . Configuration and dimensions :

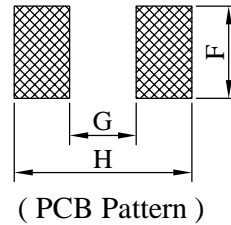
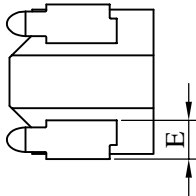
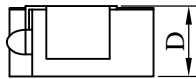
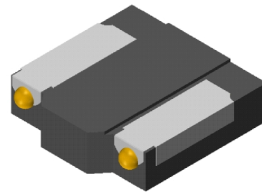
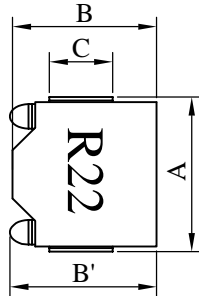

Unit : m/m

A	B	B'	C	D	E	F	G	H
4.40 ±0.2	4.10 ±0.2	4.40 max.	2.00 ref.	1.50 max.	1.10 ±0.1	2.50 ref.	1.80 ref.	4.80 ref.

II . Description :

- a . Powder molding construction
- b . Magnetically shielded
- c . Enamelled copper wire : F class
- d . Product weight : 0.16g (ref.)
- e . Moisture sensitivity Level 2a
- f . Products comply with RoHS' requirements
- g . Halogen free

Peak Temp : 260°C max.
Max. Peak Temp - 5°C : 30sec max.
Max time above 217°C : 60sec~150sec max.

III . General specification :

- a . Storage temp. : -40°C ----+125°C
- b . Operating temp. : -40°C ----+125°C
(Temp. rise included)
- c . Resistance to solder heat : 260°C .10 secs.

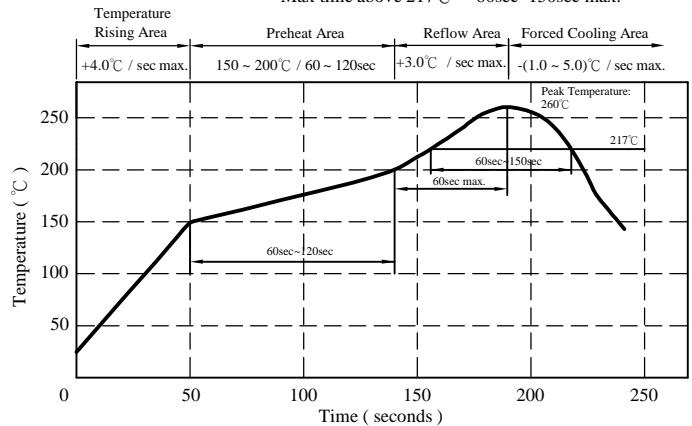

AR-001C

SPECIFICATION FOR APPROVAL

REF. :

PROD. NAME	Shielded SMD Power Inductor	ABC'S DWG NO.	HC0415□□□□S□-□□□		
		REV.	20171124-A	PAGE	2

IV . Electrical characteristics :

DWG. No.	Inductance (μH)	Test Freq. (Hz)	RDC (mΩ)		Isat (A) typ.	Irms (A) typ.
			typ.	max.		
HC0415R22KS□-□□□	0.22 ±10%	100k / 1V	5.6	6.8	15.0	12.0
HC0415R33KS□-□□□	0.33 ±10%	100k / 1V	7.5	8.9	12.5	10.2
HC0415R47KS□-□□□	0.47 ±10%	100k / 1V	9.8	11.3	11.0	8.8
HC0415R68KS□-□□□	0.68 ±10%	100k / 1V	14.0	16.2	9.4	7.3
HC04151R0KS□-□□□	1.00 ±10%	100k / 1V	25.5	30.7	8.2	4.8
HC04151R5KS□-□□□	1.50 ±10%	100k / 1V	30.7	35.5	6.2	4.7
HC04152R2KS□-□□□	2.20 ±10%	100k / 1V	45.6	52.8	5.1	3.8
HC04153R3KS□-□□□	3.30 ±10%	100k / 1V	82.4	95.4	4.0	2.7
HC04154R7KS□-□□□	4.70 ±10%	100k / 1V	105.0	122.0	3.4	2.5

- 1). Electrical specifications at 25°C
- 2). Isat base on $\Delta L / L0A=30\%$ typ.(Approximately transient current)
- 3). Irms base on temp. rise 40°C typ.

SPECIFICATION FOR APPROVAL

REF. :

PROD. NAME	Shielded SMD Power Inductor	ABC'S DWG NO.	HC0415□□□□S□-□□□		
		REV.	20171124-A	PAGE	3

V . Packaging information :

(1) Configuration

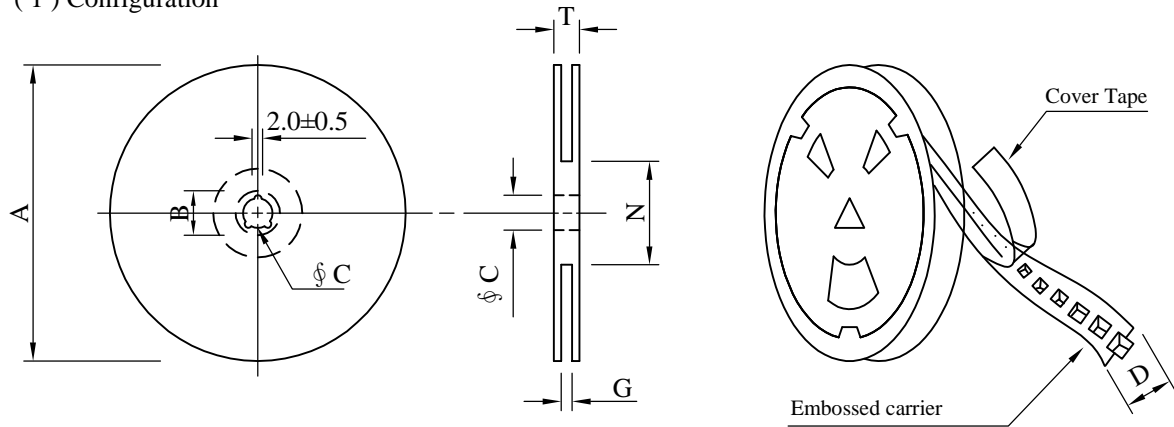

※Carrier tape width : D

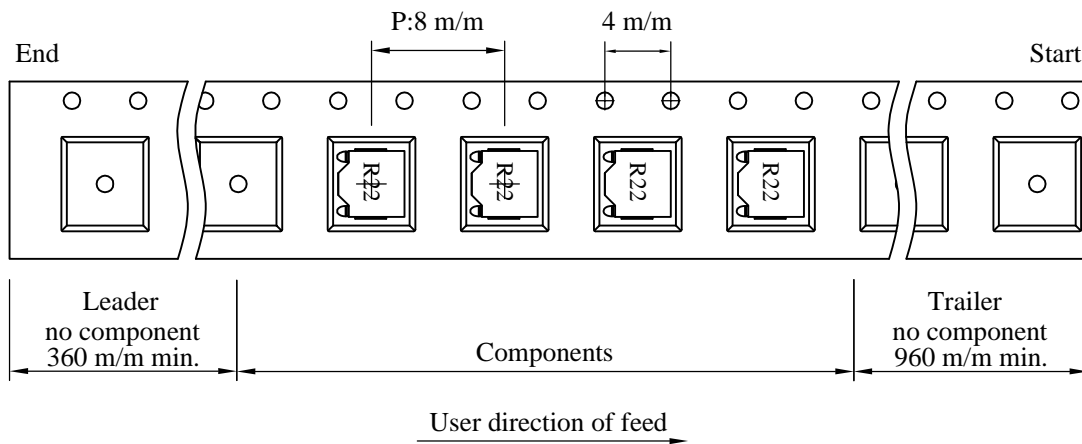

(2) Dimensions

Unit:m/m

Style	A	B	C	D	G	N	T
13 - 12	330	21±0.8	13±0.5	12	14 ⁺⁰	50 ⁻⁰	18.4

(3) Q'TY & G.W. Per package

Code	Inner : Reel			Outer : Carton		
	Q'TY (pcs)	G.W. (g)	Style	Q'TY (pcs)	G.W. (Kg)	Size (cm)
B	3,500	900	13 - 12	21,000	8.5	38 x 37 x 22

AR-001C

SPECIFICATION FOR APPROVAL

REF. :

PROD. NAME	Shielded SMD Power Inductor	ABC'S DWG NO.	HC0415□□□□S□-□□□		
		REV.	20171124-A	PAGE	4

VI . Drawing number expression :

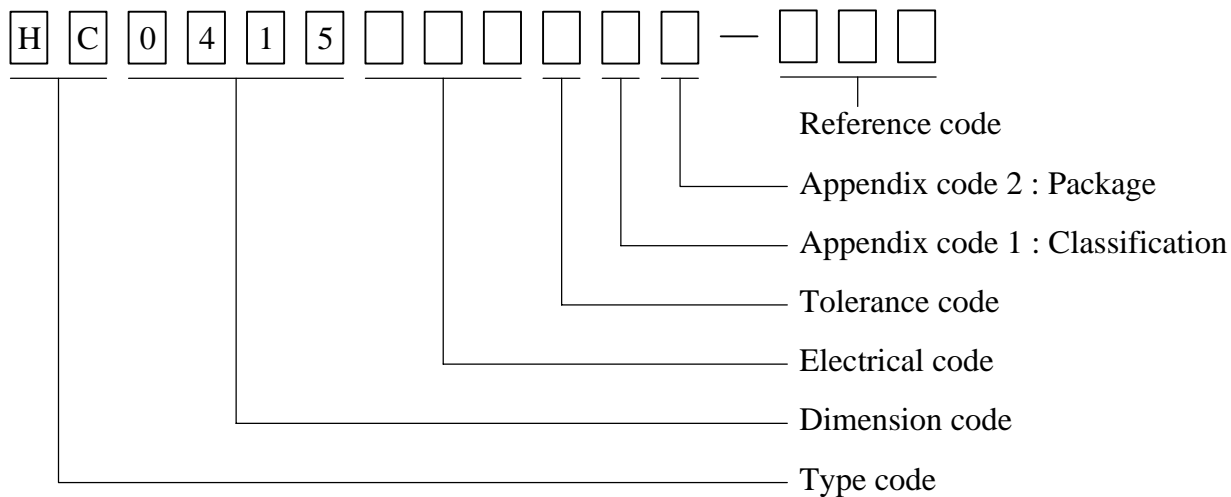

Appendix code 1 : Product Classification

Appendix code 2 : Package Information

Code	Inner package	Cover tape	Carrier tape	Bag	Package Q'TY	Remark
B	T/R (Reel package)	Heat seal	Non-antistatic	Non-antistatic	3,500 pcs	

SPECIFICATION FOR APPROVAL

REF. :

PROD. NAME	Shielded SMD Power Inductor	ABC'S DWG NO.	HC0415□□□□S□-□□□		
		REV.	20171124-A	PAGE	5

VII . Reliability test :

Item	Reference documents	Test Condition	Test Specification
1.High Temperature Exposure	MIL-STD-202 Method 108	1.Temperature: 125±2℃ 2.Time:96±2 hours.	1.No mechanical or electrical damage. 2.Inductance shall not change more than ±20%.
2.Temperature Cycling	JESD22-A 104	1.Temperature: -40℃ ~ +125℃ 2.Number of cycle:100 cycle 3.Dwell time:30 minutes	1.No mechanical or electrical damage. 2.Inductance shall not change more than ±20%.
3.Biased Humidity Test	MIL-STD-202 Method 103	1.Temperature : 85±2 ℃ 2.Humidity: 85% RH. 3.Time:96±2 Hours	1.No mechanical or electrical damage. 2.Inductance shall not change more than ±20%.
4.Operational Life	JESD22-A 108	1.Temperature: 125℃ (Temp. rise included) 2.Time:96±2 hours. 3.Rated current	1.No mechanical or electrical damage. 2.Inductance shall not change more than ±20%.
5.External Visual	JESD22-B 101 & MIL-STD-883 Method 2009	Inspect product constructions, marking and workmanship.	1.No pollution on the surface of products. 2.Clear marking. 3.No crack.
6.Physical Dimensions	JESD22-B 100	Verify physical dimensions to the applicable product detail specification.	Per product specification standard
7.Resistance to solvents	MIL-STD-202 Method 215	Immerse into solvent for 3±0.5 minutes & brush 10 times for 3 cycles.	1.No body change in appearance. 2.No marking blurred. 3.Inductance shall not change more than ±20%.
8.Vibration Test	MIL-STD-202 Method 204	1.Frequency and Amplitued : 10-2000-10 Hz, 1.5 mm. 2.Direction:X, Y, Z 3.Test duration:2 hours for each direction, 6 hours in total.	1.No mechanical or electrical damage. 2.Inductance shall not change more than ±20%.
9.Resistance To Soldering Heat Test	MIL-STD-202 Method 210 & J-STD020D.1	1.Highest temperature : 260±5℃. 2.Time (temp. ≥ 217℃) : 60~150 Seconds. 3.IR reflow times : 3 times.	1.No mechanical or electrical damage. 2.Inductance shall not change more than ±20%.
10.Saturation Current	JIS C 6436 & User SPEC.	1.Applied rated current for 5 seconds. 2.Saturation current	Inductance shall not drop more than 30% typ.
11.Over load	JIS C 6436 & User SPEC.	1.Applied one and half rated current for a period of 5 minutes. 2.Rated current	No electrical or mechanical damage
12.Temperature Rise Current	JIS C 6436 & User SPEC.	1.Applied rated current for 10 minutes. 2.Temperature measure by digital surface thermometer. 3.Irms current	Surface temperature rise is less than 40℃ typ.
13.Solderability Test	J-STD-002 & JESD22-B 102	1.Baking in pre-testing : 150±5℃ / 16Hours±30 min. 2.Peak temperature : 240±5℃ 3.Time (temp. ≥ 217℃) : 60~150 seconds. 4.IR reflow times : 1 time.	More than 95% soldering coverage min on terminations.
14.Electrical Characteriazation	MIL-STD-202 Method 304 & User SPEC.	1.Operating temperature : -40℃~125℃ 2.Room temperature : 25℃.	1.No mechanical or electrical damage. 2.Inductance shall not change more than ±20%.
15.Drop	CNS-C6354 & GB/T 2423.8	1.Products shall be mounted on SPEC. PCB and dropped down from a height of 1m 2.Drop total time : 6 times (Every side of sample drop 2 times)	1. Adhesion on PCB shall be enough. 2. Product appearance shall not break. 3. No electrical damage.
16.Terminal Strength Test	IEC 60068-2-21	1.Apply push force to samples mounted on PCB. 2.Force of 1.8 kg for 60±1 seconds.	After test, inductors shall be no mechanical damage.

AR-001C

SPECIFICATION FOR APPROVAL

REF. :

PROD. NAME	Shielded SMD Power Inductor	ABC'S DWG NO.	HC0415□□□□S□-□□□		
		REV.	20171124-A	PAGE	6

VIII . Change history :

DATE/REV.	DISCRIPTION	DRAWN	CHECKED	APPROVED
20171124-A	Released	Sammy	Leo	Nick

AR-001C