

# SPECIFICATION FOR APPROVAL

REF. :

PROD. NAME	Multilayer Chip Inductor	ABC'S DWG NO.	MH1005□□□□L□-□□□		
		REV.	20150424-E	PAGE	1

**I . Configuration and dimensions :**

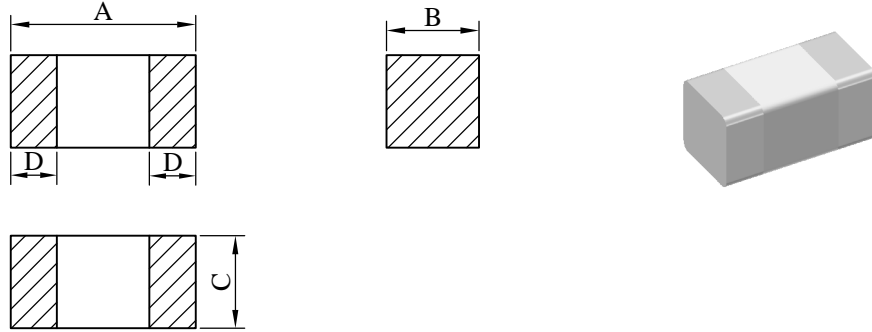

Unit : m/m

A	B	C	D
1.00 ± 0.10	0.50 ± 0.10	0.50 ± 0.10	0.20 ± 0.10

**II . Materials :**

- a . Body : Ceramic
- b . Internal conductor : Silver
- c . Terminal electrode : Ag / Ni / Sn
- d . Product weight : 1.3 mg (ref.)
- e . Products comply with RoHS' requirements
- f . Halogen free available.

**III . General specification :**

a . Storage Conditions :

Electrical Performance temp : -55°C ---- +125°C

Terminal Solderability & Packages Material temp : -10°C ---- +40°C and RH 70% max.

b . Operating temp. : -55°C ---- +125°C

c . Terminal strength :

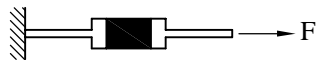

Type	F ( kgf )	Time ( sec )
MH1005	0.3	30±5

d . Resistance to soldering heat :

Solder temp. : 260°C  
Dip time : 10 sec max.

Peak Temp : 260°C max.  
Max. Peak Temp - 5°C : 30sec max.  
Max time above 217°C : 60sec~150sec max.

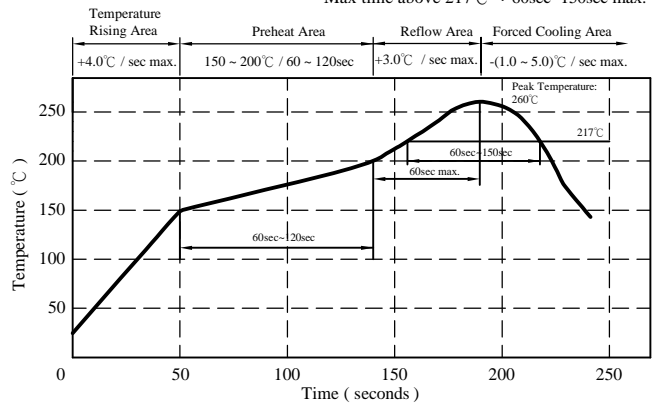

AR-001C

# SPECIFICATION FOR APPROVAL

REF. :

PROD. NAME	Multilayer Chip Inductor	ABC'S DWG NO.	MH1005□□□□L□-□□□		
		REV.	20150424-E	PAGE	2

#### IV . Electrical characteristics :

DWG No.	Inductance (nH)	Q min.	L / Q Test Freq. (MHz)	SRF (MHz) nom.	RDC (Ω) max.	IDC (mA) max.
MH10051N0DL□-□□□	1.0 ± 0.3	8	100	10000	0.07	400
MH10051N2DL□-□□□	1.2 ± 0.3	8	100	10000	0.09	400
MH10051N5DL□-□□□	1.5 ± 0.3	8	100	9000	0.10	400
MH10051N8DL□-□□□	1.8 ± 0.3	8	100	8700	0.10	400
MH10052N2DL□-□□□	2.2 ± 0.3	8	100	8100	0.12	400
MH10052N7DL□-□□□	2.7 ± 0.3	8	100	7700	0.15	400
MH10053N3DL□-□□□	3.3 ± 0.3	8	100	6300	0.15	400
MH10053N9DL□-□□□	3.9 ± 0.3	8	100	6100	0.18	400
MH10054N7DL□-□□□	4.7 ± 0.3	8	100	6000	0.18	400
MH10055N6DL□-□□□	5.6 ± 0.3	8	100	5100	0.20	400
MH10056N8JL□-□□□	6.8 ± 5%	8	100	4550	0.24	400
MH10058N2JL□-□□□	8.2 ± 5%	8	100	4100	0.24	300
MH100510NJL□-□□□	10.0 ± 5%	8	100	3900	0.26	300
MH100512NJL□-□□□	12.0 ± 5%	8	100	3000	0.40	300
MH100515NJL□-□□□	15.0 ± 5%	8	100	2800	0.50	300
MH100518NJL□-□□□	18.0 ± 5%	8	100	2500	0.55	300
MH100522NJL□-□□□	22.0 ± 5%	8	100	2200	0.70	300
MH100527NJL□-□□□	27.0 ± 5%	8	100	2000	0.80	300
MH100533NJL□-□□□	33.0 ± 5%	8	100	1800	0.90	200
MH100539NJL□-□□□	39.0 ± 5%	8	100	1600	1.00	150
MH100547NJL□-□□□	47.0 ± 5%	8	100	1400	1.20	150
MH100556NJL□-□□□	56.0 ± 5%	8	100	1300	1.30	150
MH100568NJL□-□□□	68.0 ± 5%	8	100	1100	1.50	100
MH100582NJL□-□□□	82.0 ± 5%	8	100	1000	1.60	100
MH1005R10JL□-□□□	100.0 ± 5%	8	100	900	2.00	100

- 1). □ : Packaging information : □ Code
- 2). "-□□□" : Reference code
- 3). Electrical specifications at 25°C

# SPECIFICATION FOR APPROVAL

REF. :

PROD. NAME	Multilayer Chip Inductor	ABC'S DWG NO.	MH1005□□□□L□-□□□		
		REV.	20150424-E	PAGE	3

V . Curve :

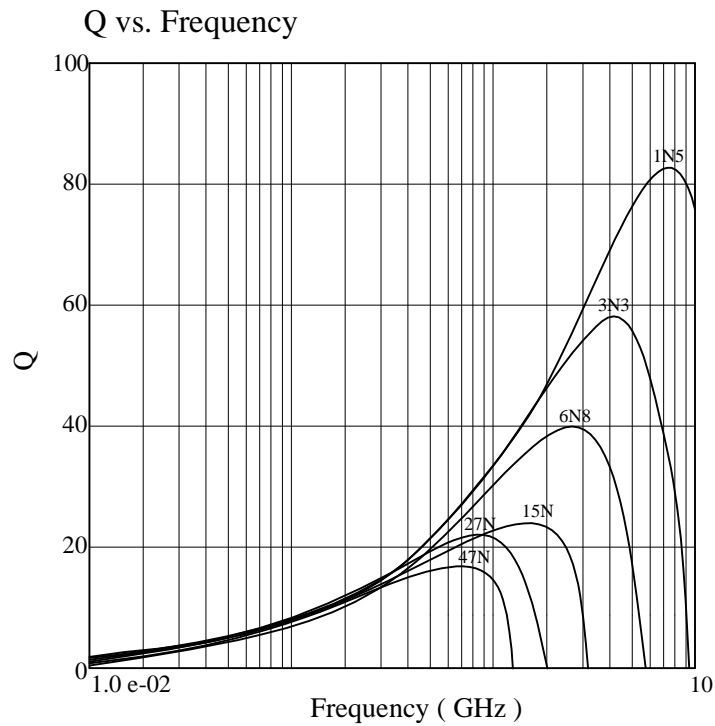
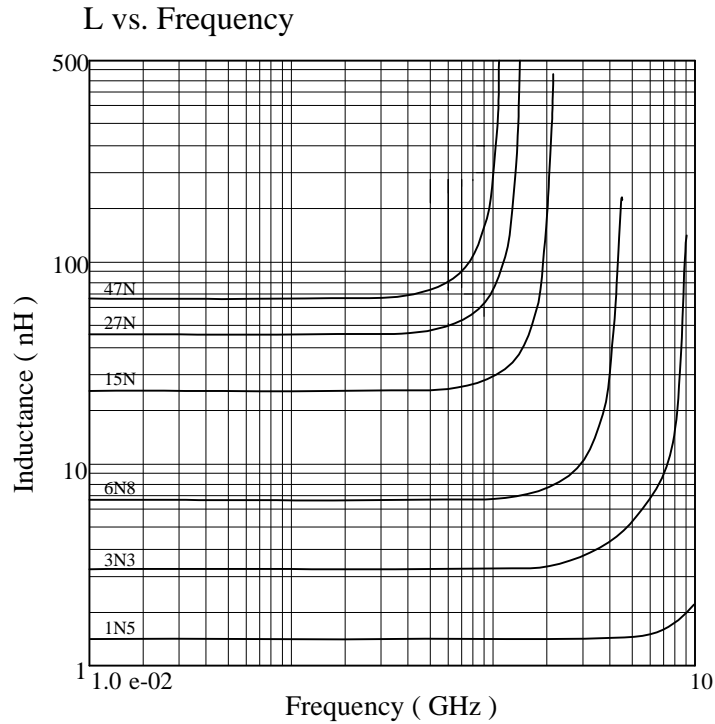

AR-001C

# SPECIFICATION FOR APPROVAL

REF. :

PROD. NAME	Multilayer Chip Inductor	ABC'S DWG NO.	MH1005□□□□L□-□□□		
		REV.	20150424-E	PAGE	4

## VI . Packaging information :

### (1) Configuration

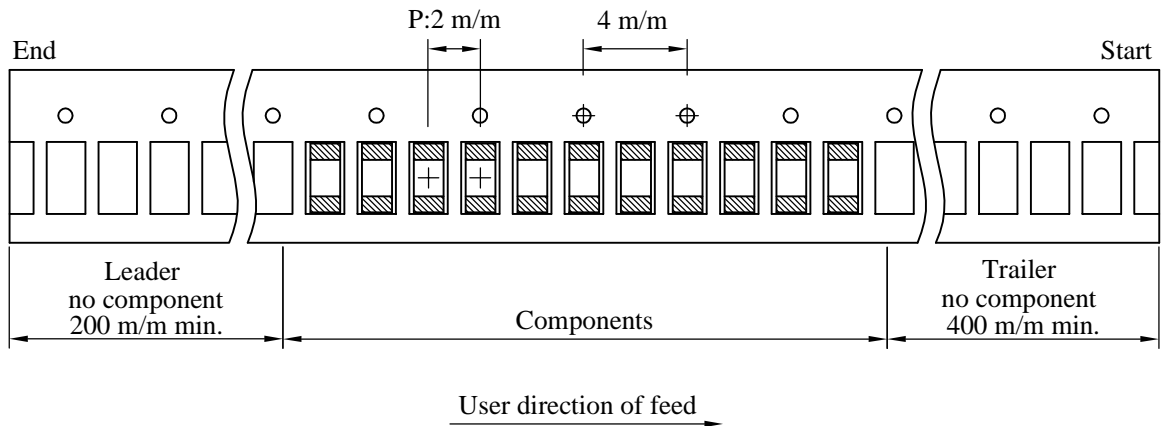
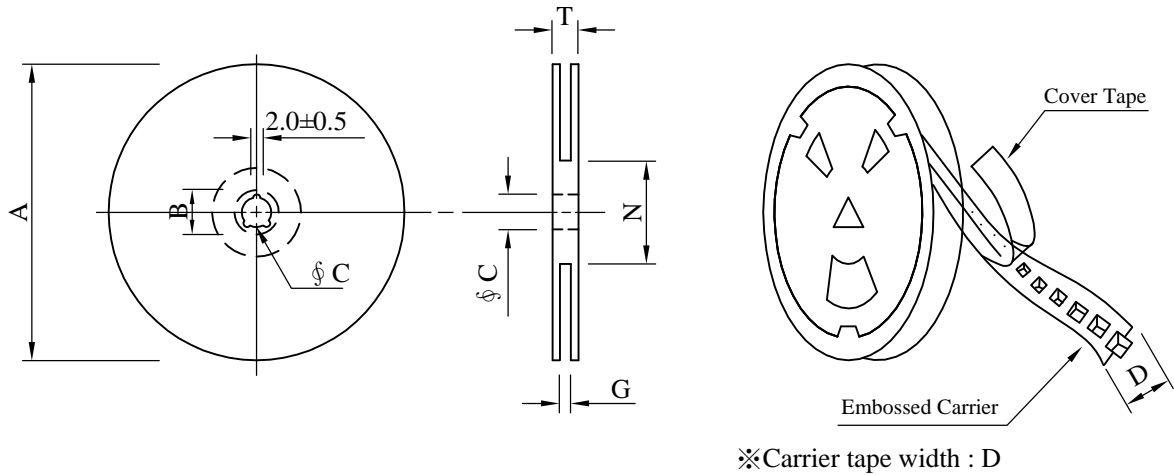

### (2) Dimensions

Unit:m/m

Style	A	B	C	D	G	N	T
07 - 08	178	21±0.8	13	8	10 <sup>+0</sup>	50 <sup>-0</sup>	12.5

### (3) Q'TY & G.W. Per package

Code	Inner : Reel			Outer : Carton		
	Q'TY (pcs)	G.W. (gw)	Style	Q'TY(kpcs)	G.W. (Kg)	Size (cm)
B	10,000	60	07 - 08	500	5.5	42 x 41 x 24

AR-001C

# SPECIFICATION FOR APPROVAL

REF. :

PROD. NAME	Multilayer Chip Inductor	ABC'S DWG NO.	MH1005□□□□L□-□□□		
		REV.	20150424-E	PAGE	5

**VII . Reliability test :**

Item	Reference documents	Test Condition	Test Specification
1.High Temperature Exposure	MIL-STD-202 Method 108	1.Temperature: 125°C 2.Time:1008 hours. 3.Measurement : After placing for 24 hours min.	1.Body: No damage 2.Inductance shall not change more than ±20%.
2.Low Temperature Exposure	JESD22-A 119	1.Temperature: -55°C 2.Time:1008 hours. 3.Measurement : After placing for 24 hours min.	1.Body: No damage 2.Inductance shall not change more than ±20%.
3.Temperature Cycling	JESD22-A 104	1.Temperature: -55°C ~ 125°C 2.Number of cycle:100 cycle 3.Dwell time:30 minutes 4.Measurement : After placing for 24 hours min.	1.Body: No damage 2.Inductance shall not change more than ±20%.
4.Biased Humidity Test	MIL-STD-202 Method 103	1.Temperature:40±5 °C 2.Time:1008 Hours 3.Humidity: 95% RH. 4.Measurement : After placing for 24 hours min.	1.Body: No damage 2.Inductance shall not change more than ±20%.
5.Vibration Test	MIL-STD-202 Method 204	1.Frequency and Amplitued : 10-55-10 Hz, 1.5 mm. 2.Direction:X, Y, Z 3.Test duration:2 hours for each direction, 6 hours in total.	Appearance: No damage
6.Resistance To Soldering Heat Test	MIL-STD-202 Method 210	1.Solder Temp. : 265±3°C 2.Immersion time : 6±1 sec 3.Preheating : 100°C to 150°C, 1 minute. 4.Measurement : After placing for 24 hours min.	1.Appearance: No damage 2.Inductance shall not change more than ±20%.
7.Solderability Test	J-STD-002	1.Preheat : 150°C, 60 seconds 2.Solder temperature : 245±5°C 3.Flux 4.Dip time : 4±1 seconds	The terminal shall be at least 90% covered with fresh solder.
8.Terminal Strength Test	IEC 60068-2-21	1.Apply push force to samples mounted on PCB. 2.Force: Refer to product specification. 3.Dwell time : >25 seconds.	The terminal electrode and the body shall not be damaged by the forces applied on the right conditions.
9.Board Flex	JIS-C-6429	1.Deflection speed : 1 mm/ sec 2.Amount of deflection : 2 mm 3.Span : 90 mm 4.Direction for test : Bottom of PCB 5.Holding time : 60 seconds.	1.Appearance: No damage 2.The terminal electrode and the body shall not be damaged by the forces applied on the right conditions.

AR-001C