



MULTI-INNO TECHNOLOGY CO., LTD.

www.multi-inno.com

LCD MODULE SPECIFICATION

Model : MI0240S1T-1

This module uses ROHS material

For Customer's Acceptance:

Customer	
Approved	
Comment	

This specification may change without prior notice in order to improve performance or quality. Please contact Multi-Inno for updated specification and product status before design for this product or release of this order.

Revision	1.3
Engineering	
Date	2013-10-11
Our Reference	



REVISION RECORD

REV NO.	REV DATE	CONTENTS	REMARKS
1.0	2012-09-06	First release	
1.1	2012-11-22	Change B/L	
1.2	2013-10-11	Correct PIN6 description	
1.3	2015-12-16	Change IC driver from ILI9341 to ILI9341V	P.4~5



CONTENTS

- GENERAL INFORMATION
- EXTERNAL DIMENSIONS
- ABSOLUTE MAXIMUM RATINGS
- ELECTRICAL CHARACTERISTICS
- BACKLIGHT CHARACTERISTICS
- ELECTRO-OPTICAL CHARACTERISTICS
- INTERFACE DESCRIPTION
- REFERENCE APPLICATION CIRCUIT
- REFERENCE INITIAL CODE
- RELIABILITY TEST
- INSPECTION CRITERION
- PRECAUTIONS FOR USING LCD MODULES
- PRIOR CONSULT MATTER

**■ GENERAL INFORMATION**

Item	Contents	Unit/note
LCD type	TFT/ Transmissive	/
Viewing direction	6:00 (without image inversion and least brightness change)	O' Clock
Gray scale inversion direction	12:00 (contrast peak located at)	O' Clock
Module area (W × H)	42.72 × 60.26 × 2.35	mm ³
Active area (W×H)	36.72 × 48.96	mm ²
Number of Dots	240RGB × 320	/
Dot size (W × H)	0.051 × 0.153	mm ²
Dot pitch (W × H)	0.153 × 0.153	mm ²
Pixel arrangement	RGB vertical stripe	/
Driver IC	ILI9341V	/
Colors	65K/262K	/
Backlight Type	4LEDs	/
Interface Type	8/16bit CPU	/
Input voltage	2.8	V
Module weight	TBD	g
With/without TSP	Without TSP	/

Note 1: RoHS compliant;

Note 2: LCM weight tolerance: ± 5% .

EXTERNAL DIMENSIONS

PIN ASSIGNMENT:

PIN SYMBOL	FUNCTION
1	GND
2	YD(NC)
3	XL(NC)
4	YU(NC)
5	XR(NC)
6	LED_ID
7	VCC
8	I0VCC
9	FMARK
10	CS
11	RS
12	WR
13	RD
14	DB0
15	DB1
16	DB2
17	DB3
18	DB4
19	DB5
20	DB6
21	DB7
22	DB8
23	DB9
24	DB10
25	DB11
26	DB12
27	DB13
28	DB14
29	DB15
30	RESSET
31	I/MO
32	NC
33	GND
34	LED-K1
35	LED-K2
36	LED-K3
37	LED-K4
38	LED-A
39	GND
40	NC

NOTES:

1. DISPLAY TYPE: TFT TRANSMISSIVE
2. DRIVE METHOD: VDD=2.8V
3. VIEWING DIRECTION: 6 O'CLOCK
4. IC DRIVER: LI9341V
5. OPERATING TEMP: -20°C ~ 70°C
6. STORAGE TEMP: -30°C ~ 80°C
7. LED BACKLIGHT: WHITE LED, I_f=15mA, V_f=3.2±0.2V
8. GENERAL TOLERANCE: ±0.2
9. RECOMMENDED CASE OPEN AREA SHOULD BE LESS THAN MODULE V.A.
10. CONNECT: FH95C-40S-0.5SH
11. ROHS COMPLIANT

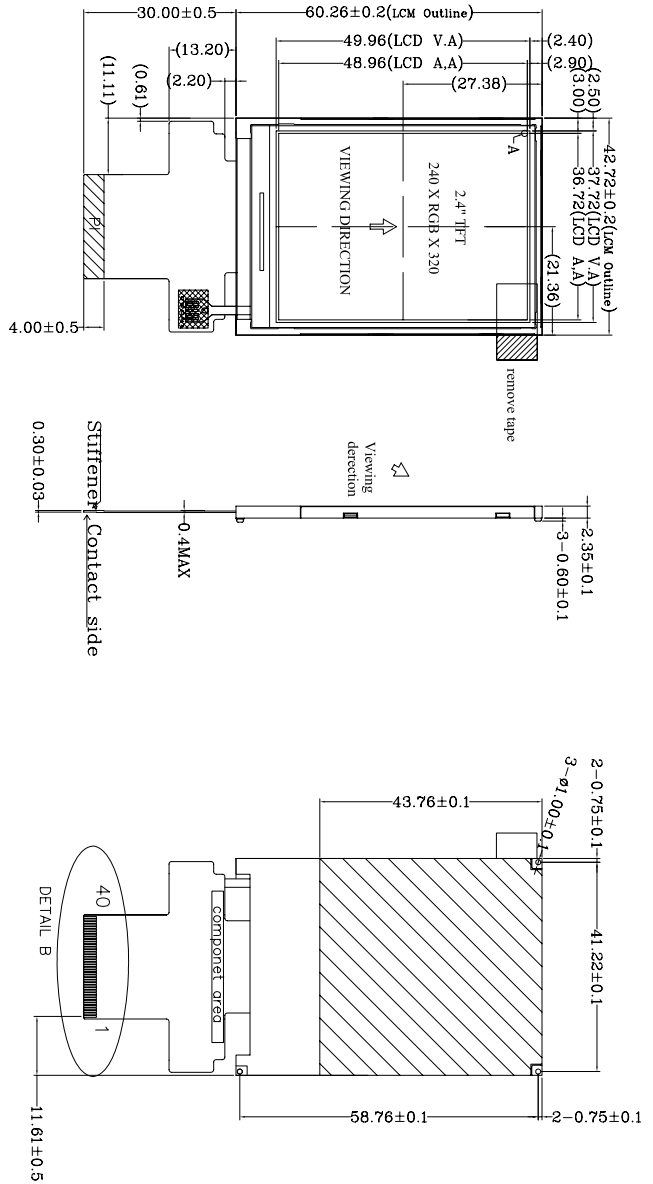

CIRCUIT DIAGRAM

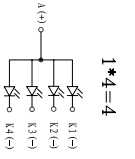

DETAIL A
SCALE: 40:1

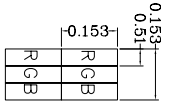

DETAIL B
SCALE: 4:1

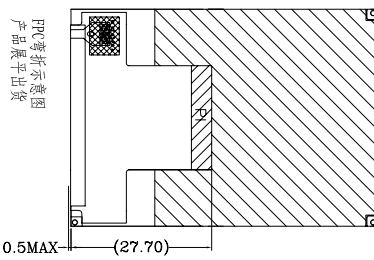
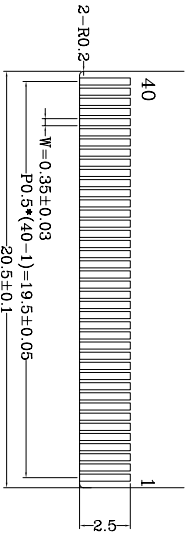

VER.	REVISED DESCRIPTION	DATE
02	Change IC driver from LI9341 to LI9341V	2015.12.16
01	FIRST ISSUE	2012.11.22



MULTI-INNO TECHNOLOGY CO.,LTD.

DRAWN BY: CAROL	2015.12.16	SCALE: 1/1	MODULE P/N: MI0240S1T-1
CHECKED BY:		UNIT: mm	DESCRIPTION: TFT MODULE
APPROVED BY:			
VERSION NO: 02			

■ ABSOLUTE MAXIMUM RATINGS

Parameter	Symbol	Min	Max	Unit
Supply voltage for logic	V _{CC} , IOV _{CC}	-0.3	4.6	V
Input voltage	V _{IN}	-0.3	IOV _{CC} +0.3	V
Operating temperature	T _{OP}	-20	70	°C
Storage temperature	T _{ST}	-30	80	°C
Humidity	RH		90%(Max60°C)	RH

■ ELECTRICAL CHARACTERISTICS

DC CHARACTERISTICS

Parameter of DC characteristics	Symbol	Min	Typ	Max	Unit
Supply voltage for logic	IOVCC	1.65	1.8/2.8	3.3	V
Analog supply voltage	VCC	2.3	2.8	3.3	V
Input voltage 'H' level	VIH	-	-	0.2IOVCC	V
Input voltage 'L' level	VIL	0.8IOVCC	-	IOVCC	V
Output voltage 'H' level	VOH	-	-	0.2IOVCC	V
Output voltage 'L' level	VOL	0.8IOVCC	-	-	V
(Panel+LSI) power consumption	Black mode (60Hz)	-	21.64	-	mW
	8 color mode	-	5.897	-	mW
	Sleeping mode	-	0.095	-	mW

■ BACKLIGHT CHARACTERISTICS

Item of backlight characteristics	Symbol	Min.	Typ.	Max.	Unit	Condition
Forward voltage	V _f	2.9	3.2	3.4	V	If=15mA Ta=25°C
Number of LED	-	-	4	-	Piece	-
Power consumption	W _{BL}	-	192	-	mW	4 LEDs

Note1: Figure below shows the connection of backlight LED.

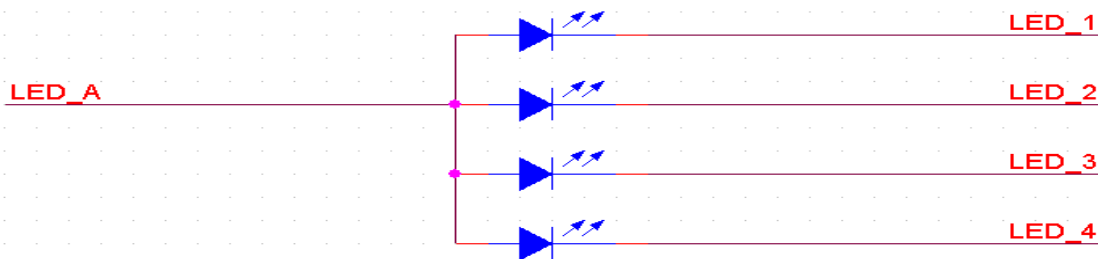

Note 2: One LED: $1/4 \times I_F = 15 \text{ mA}$, $V_F = 3.2 \text{ V}$

■ELECTRO-OPTICAL CHARACTERISTICS

Item of electro-optical characteristics	Symbol	Condition	Min	Typ	Max	Unit	Remark	Note
Response time	Tr+ Tf	$\theta=0^\circ$ $\varnothing=0^\circ$ $T_a=25^\circ\text{C}$	-	20	30	ms	Fig.1	4
Contrast ratio	Cr		400	500	-	---	FIG 2.	1
Luminance uniformity	δ WHITE		-	80	-	%	FIG 2.	3
Surface Luminance	Lv		-	310	-	cd/m ²	FIG 2.	2
Viewing angle range	θ	$\varnothing = 90^\circ$	60	70	-	deg	FIG 3.	6
		$\varnothing = 270^\circ$	50	60	-	deg	FIG 3.	
		$\varnothing = 0^\circ$	60	70	-	deg	FIG 3.	
		$\varnothing = 180^\circ$	60	70	-	deg	FIG 3.	
NTSC ratio	---	---	-	53	-	%	-	-
CIE (x, y) chromaticity	Red x	$\theta=0^\circ$ $\varnothing=0^\circ$ $T_a=25^\circ\text{C}$	0.542	0.592	0.642	-	FIG 2.	5
	Red y		0.294	0.344	0.394	-		
	Green x		0.285	0.332	0.385	-		
	Green y		0.531	0.581	0.631	-		
	Blue x		0.099	0.149	0.199	-		
	Blue y		0.054	0.104	0.154	-		
	White x		0.240	0.290	0.340	-		
	White y		0.270	0.320	0.370	-		

Note1. Contrast Ratio(CR) is defined mathematically by the following formula. For more information see FIG 2.:

$$\text{ContrastRatio} = \frac{\text{AverageSurface Luminance with all white pixels (P 1,P2, P 3,P4, P5)}}{\text{Average SurfaceLuminance with all black pixels (P1, P2, P 3,P4, P5)}}$$

Note2. Surface luminance is the LCD surface from the surface with all pixels displaying white. For more information see FIG 2.

$$L_v = \text{Average Surface Luminance with all white pixels (P1, P2, P 3,P4, P5)}$$

Note3. The uniformity in surface luminance (δ WHITE) is determined by measuring luminance at each test position 1 through 5, and then dividing the maximum luminance of 5 points luminance by minimum luminance of 5 points luminance. For more information see FIG 2.

$$\delta \text{ WHITE} = \frac{\text{Minimum Surface Luminance with all white pixels (P}_1, \text{P}_2, \text{P}_3, \text{P}_4, \text{P}_5)}{\text{Maximum Surface Luminance with allwhite pixels (P}_1, \text{P}_2, \text{P}_3, \text{P}_4, \text{P}_5)}$$

Note4. Response time is the time required for the display to transition from White to black(Rise Time, Tr) and from black to white(Decay Time, Tf). For additional information see FIG 1..

Note5. CIE (x, y) chromaticity ,The x,y value is determined by screen active area position 5. For more information see FIG 2.

Note6. Viewing angle is the angle at which the contrast ratio is greater than 2. For TFT module the contrast ratio is greater than 10. The angles are determined for the horizontal or x axis and the vertical or y axis with respect to the z axis which is normal to the LCD surface. For more information see FIG 3.

Note7. For Viewing angle and response time testing, the testing data is base on Autronic-Melchers's ConoScope. Series Instruments. For contrast ratio, Surface Luminance, Luminance uniformity and CIE, the testing data is base on TOPCON's BM-5 photo detector.

Note8. For TFT transmissive module,Gray scale reverse occurs in the direction of panel viewing angle.

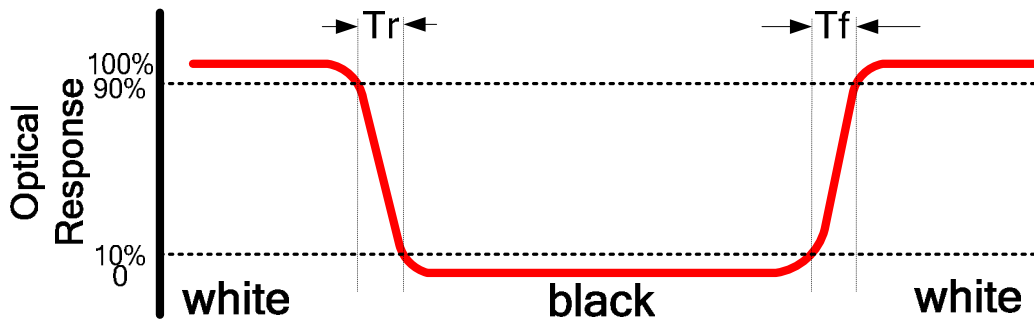
FIG.1. The definition of Response Time

FIG.2. Measuring method for Contrast ratio, surface luminance, Luminance uniformity, CIE (x, y) chromaticity

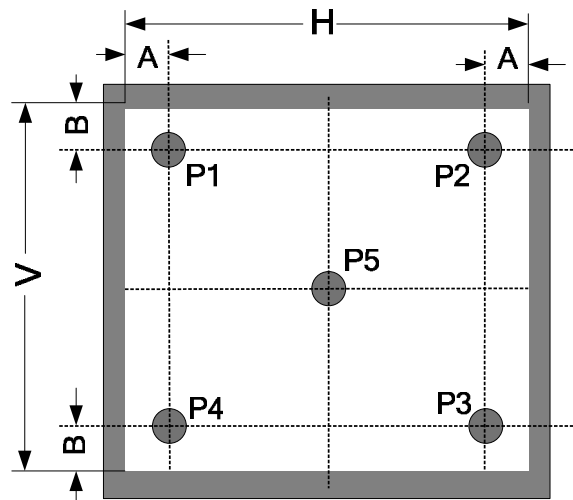
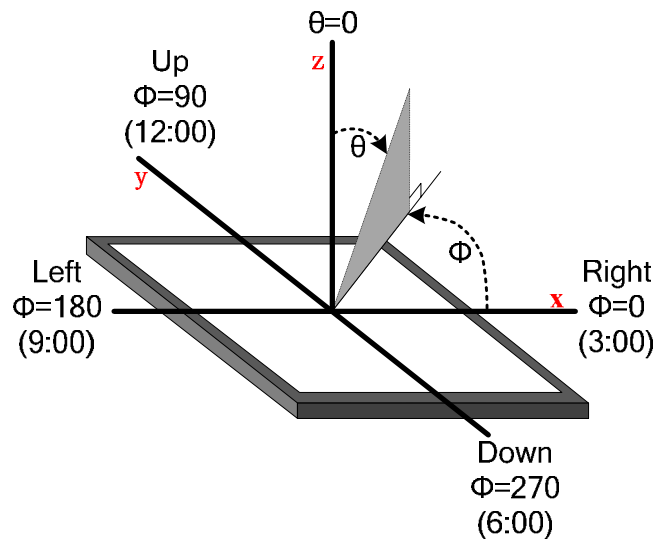
A : 5 mm
 B : 5 mm
 H, V : Active Area
 Light spot size $\varnothing=5\text{mm}$, 500mm distance from the LCD surface to detector lens
 measurement instrument is TOPCON's luminance meter BM-5

FIG.3. The definition of viewing angle



■ INTERFACE DESCRIPTION

No	Symbol	I/O	Description	Comment
1	GND	P	Power Ground	
2	YD	O	Floating	
3	XL	O	Floating	
4	YU	O	Floating	
5	XR	O	Floating	
6	LCD_ID	-	No connection	
7	VCC	P	Power Supply of Analog	
8	IOVCC	P	Power Supply of Logic	
9	FMARK	O	Tearing effect output pin to synchronize MPU to frame writing	
10	CS	I	Chip select signal	
11	RS	I	Register select signal	
12	WR	I	Write enables signal	
13	RD	I	Read enables signal	
14	DB0	I/O	Data Input	
15	DB1	I/O	Data Input	
16	DB2	I/O	Data Input	
17	DB3	I/O	Data Input	
18	DB4	I/O	Data Input	
19	DB5	I/O	Data Input	
20	DB6	I/O	Data Input	
21	DB7	I/O	Data Input	
22	DB8	I/O	Data Input	
23	DB9	I/O	Data input	
24	DB10	I/O	Data input	
25	DB11	I/O	Data input	
26	DB12	I/O	Data input	
27	DB13	I/O	Data input	
28	DB14	I/O	Data input	
29	DB15	I/O	Data input	
30	RESET	I	Reset signal	
31	IM0	I	Mode select signal	Note2
32	NC	-	Floating	
33	GND	P	Power Ground	
34	LED_1	P	LED light cathode	
35	LED_2	P	LED light cathode	
36	LED_3	P	LED light cathode	
37	LED_4	P	LED light cathode	
38	LED_A	P	LED light anode	
39	GND	P	Power Ground	
40	NC	-	Floating	

Note1: I/O definition: I----Input O---Output P----Power/ Ground NC--- Not Connected

Note2:

IM0	Interface	Data Bus Use	
		Register/Content	GRAM
0	8080 MCU 16_Bit Parallel	DB7~DB0	DB15~DB0
1	8080 MCU 8_Bit Parallel	DB15~DB8	DB15~DB8

Block Diagram

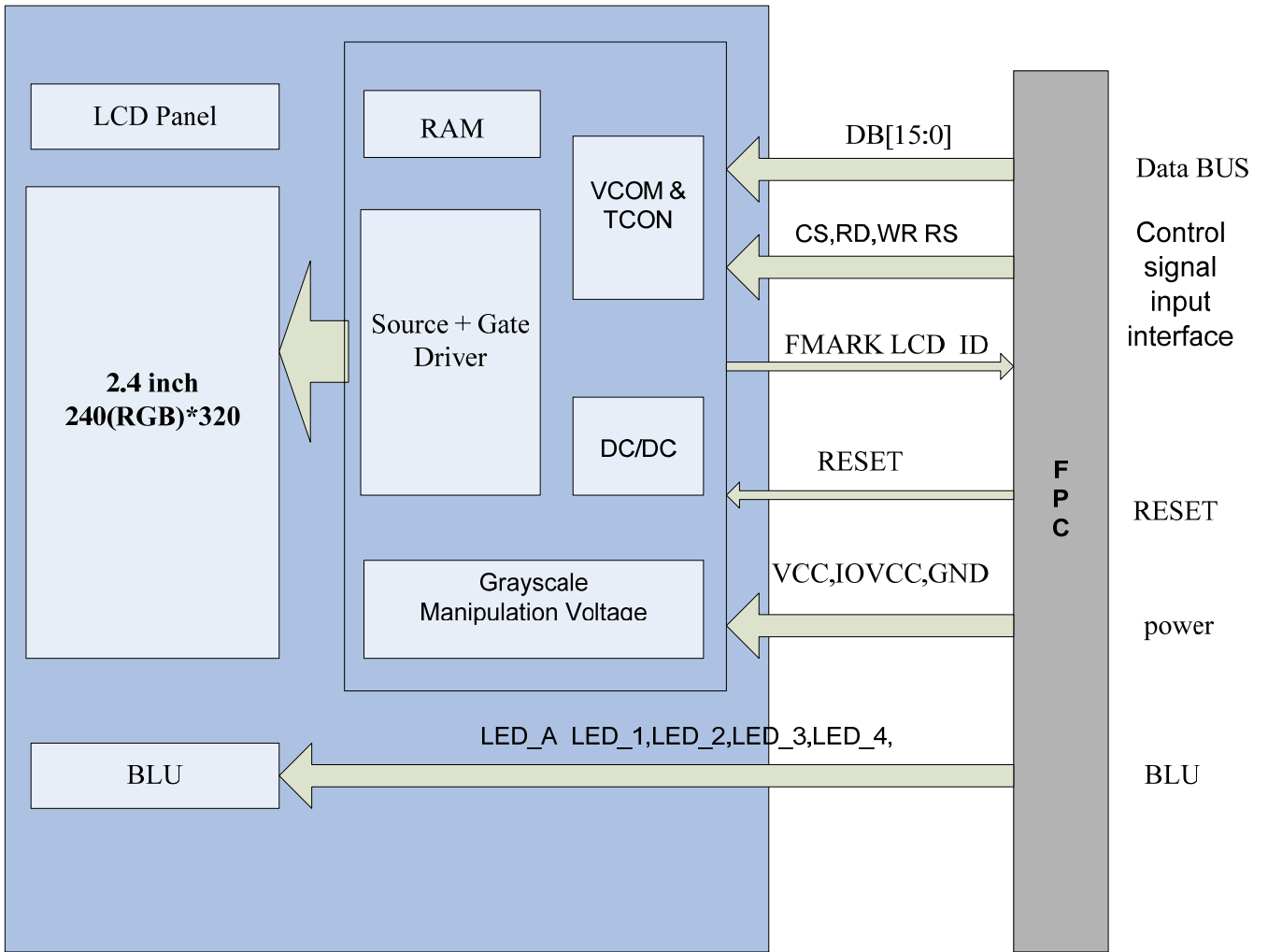

**■ APPLICATION CIRCUIT**

Please consult our technical department for detail information.

■ INITIAL CODE

Please consult our technical department for detail information.

■ RELIABILITY TEST

No.	Test Item	Test Condition	Inspection after test
1	High Temperature Storage	$80 \pm 2^{\circ}\text{C}/240\text{hours}$	1. Functional test is OK. Missing Segment, short, unclear segment, non-display, display abnormally and liquid crystal leak are un-allowed. 2. No low temperature bubbles, end seal loose and fall, frame rainbow.
2	Low Temperature Storage	$-30 \pm 2^{\circ}\text{C}/240\text{hours}$	
3	High Temperature Operating	$70 \pm 2^{\circ}\text{C}/240\text{hours}$	
4	Low Temperature Operating	$-20 \pm 2^{\circ}\text{C}/240\text{hours}$	
5	Temperature Cycle	$-20 \pm 2^{\circ}\text{C} \sim 25 \sim 70 \pm 2^{\circ}\text{C} \times 10\text{cycles}$ (30min.) (5min.) (30min.)	
6	Damp Proof Test	$40^{\circ}\text{C} \pm 5^{\circ}\text{C} \times 90\%\text{RH}/240\text{hours}$	
7	Vibration Test	Frequency: 10Hz~55Hz Amplitude: 1.0mm, Each direction on X,Y axe 0.5 hours, circle 2 hours	1. Function test is OK. 2. No glass crack, chipped glass, end seal loose and fall, epoxy frame crack 3. No structure loose and fall.
8	Dropping test	Drop to the ground from 80cm height, one time, every side of carton.	

■ INSPECTION CRITERIA

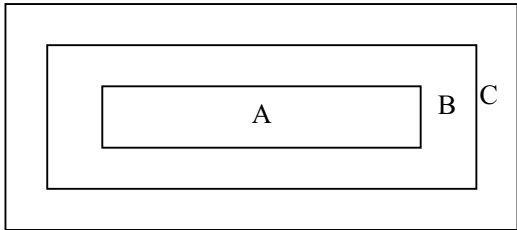
 <p>OUTGOING QUALITY STANDARD</p>	<p>PAGE 1 OF 4</p>
<p>TITLE:FUNCTIONAL TEST & INSPECTION CRITERIA</p>	<p>MDS Product</p>
<p>This specification is made to be used as the standard acceptance/rejection criteria for TFT module.</p> <p>1 Sample plan</p> <p>Sampling plan according to GB/T2828.1-2003/ISO 2859-1: 1999 and ANSI/ASQC Z1.4-1993, normal level 2 and based on:</p> <p>Major defect: AQL 0.65</p> <p>Minor defect: AQL 1.5</p> <p>2. Inspection condition</p> <p>Viewing distance for cosmetic inspection is about 30cm with bare eyes, and under an environment of 20~40W light intensity, all directions for inspecting the sample should be within 45° against perpendicular line.</p> <p>3. Definition of inspection zone in LCD.</p> <div data-bbox="491 1162 1010 1391" data-label="Diagram">  <p>The diagram shows three nested rectangles representing inspection zones. The innermost rectangle is labeled 'A'. The middle rectangle is labeled 'B' on its right side. The outermost rectangle is labeled 'C' on its right side.</p> </div> <p>Zone A: character/Digit area</p> <p>Zone B: viewing area except Zone A (ZoneA+ZoneB=minimum Viewing area)</p> <p>Zone C: Outside viewing area (invisible area after assembly in customer's product)</p> <p>Fig.1 Inspection zones in an LCD.</p> <p>Note: As a general rule, visual defects in Zone C are permissible, when it is no trouble for quality and assembly of customer's product.</p>	

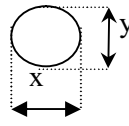
OUTGOING QUALITY STANDARD		PAGE 2 OF 4																										
TITLE:FUNCTIONAL TEST & INSPECTION CRITERIA		MDS Product																										
4. Inspection standards																												
4.1 Major Defect																												
Item No	Items to be inspected	Inspection Standard	Classification of defects																									
4.1.1	All functional defects	1) No display 2) Display abnormally 3) Missing vertical, horizontal segment 4) Short circuit 5) Back-light no lighting, flickering and abnormal lighting.	Major																									
4.1.2	Missing	Missing component																										
4.1.3	Outline dimension	Overall outline dimension beyond the drawing is not allowed.																										
4.2 Cosmetic Defect																												
Item No	Items to be inspected	Inspection Standard	Classification of defects																									
4.2.1	Clear Spots	For dark/white spot, size Φ is defined as $\Phi = \frac{(x+y)}{2}$ 	Minor																									
	Black and white Spot defect Pinhole, Foreign Particle, Dirt under polarizer	1. <table border="1" data-bbox="414 1232 1141 1612"> <thead> <tr> <th rowspan="2">Zone Size(mm)</th> <th colspan="3">Acceptable Qty</th> </tr> <tr> <th>A</th> <th>B</th> <th>C</th> </tr> </thead> <tbody> <tr> <td>$\Phi \leq 0.10$</td> <td colspan="3">Ignore</td> </tr> <tr> <td>$0.10 < \Phi \leq 0.15$</td> <td colspan="3">2</td> </tr> <tr> <td>$0.15 < \Phi \leq 0.20$</td> <td colspan="3">1</td> </tr> <tr> <td>$\Phi > 0.20$</td> <td colspan="3">0</td> </tr> </tbody> </table>		Zone Size(mm)	Acceptable Qty			A	B	C	$\Phi \leq 0.10$	Ignore			$0.10 < \Phi \leq 0.15$	2			$0.15 < \Phi \leq 0.20$	1			$\Phi > 0.20$	0				
Zone Size(mm)	Acceptable Qty																											
	A	B	C																									
$\Phi \leq 0.10$	Ignore																											
$0.10 < \Phi \leq 0.15$	2																											
$0.15 < \Phi \leq 0.20$	1																											
$\Phi > 0.20$	0																											
4.2.1	Dim Spots	2.	Minor																									
	Circle shaped and dim edged defects	<table border="1" data-bbox="414 1691 1117 2105"> <thead> <tr> <th rowspan="2">2. Zone Size(mm)</th> <th colspan="3">Acceptable Qty</th> </tr> <tr> <th>A</th> <th>B</th> <th>C</th> </tr> </thead> <tbody> <tr> <td>$\Phi \leq 0.2$</td> <td colspan="3">Ignore</td> </tr> <tr> <td>$0.20 < \Phi \leq 0.40$</td> <td colspan="3">3</td> </tr> <tr> <td>$0.40 < \Phi \leq 0.60$</td> <td colspan="3">2</td> </tr> <tr> <td>$0.60 < \Phi \leq 0.80$</td> <td colspan="3">1</td> </tr> <tr> <td>$0.80 < \Phi$</td> <td colspan="3">0</td> </tr> </tbody> </table>		2. Zone Size(mm)	Acceptable Qty			A	B	C	$\Phi \leq 0.2$	Ignore			$0.20 < \Phi \leq 0.40$	3			$0.40 < \Phi \leq 0.60$	2			$0.60 < \Phi \leq 0.80$	1			$0.80 < \Phi$	0
2. Zone Size(mm)	Acceptable Qty																											
	A	B	C																									
$\Phi \leq 0.2$	Ignore																											
$0.20 < \Phi \leq 0.40$	3																											
$0.40 < \Phi \leq 0.60$	2																											
$0.60 < \Phi \leq 0.80$	1																											
$0.80 < \Phi$	0																											

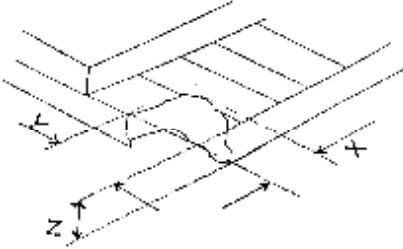
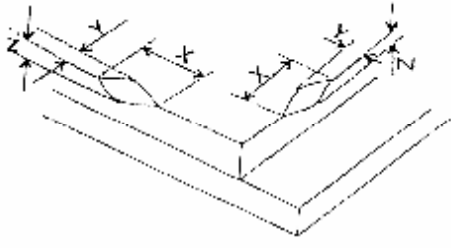
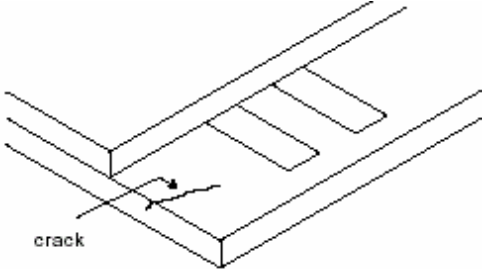

OUTGOING QUALITY STANDARD		PAGE 3 OF 4					
TITLE: FUNCTIONAL TEST & INSPECTION CRITERIA		MDS Product					
4.2. Cosmetic Defect							
Item No	Items to be inspected	Inspection Standard			Classification of defects		
4.2.2	Line defect Black line, White line, Foreign material under polarizer,	Size(mm)		Acceptable Qty		Minor	
		L(Length)	W(Width)	Zone			
				A	B		C
		Ignore	$W \leq 0.02$	Ignore			Ignore
		$L \leq 3.0$	$0.02 < W \leq 0.03$	2			
		$L \leq 2.0$	$0.03 < W \leq 0.05$	1			
	$0.05 < W$	Define as spot defect					
4.2.3	Polarizer scratch	Size(mm)		Acceptable Qty		Minor	
		L(Length)	W(Width)	Zone			
				A	B		C
		Ignore	$W \leq 0.03$	Ignore			Ignore
		$5.0 < L \leq 10.0$	$0.03 < W \leq 0.05$	2			
		$L \leq 5.0$	$0.05 < W \leq 0.08$	1			
	$0.08 < W$	0					
4.2.4	Polarize Air bubble	Air bubbles between glass & polarizer				Minor	
		2. Zone Size(mm)	Acceptable Qty				
			A	B	C		
		$\Phi \leq 0.2$	Ignore		Ignore		
		$0.20 < \Phi \leq 0.30$	2				
$0.30 < \Phi \leq 0.50$	1						
$0.50 < \Phi$	0						

OUTGOING QUALITY STANDARD		PAGE 4 OF 4							
TITLE:FUNCTIONAL TEST & INSPECTION CRITERIA		MDS Product							
4.3. Cosmetic Defect									
4.3.5	Glass defect	(i) Chips on corner  <table border="1" data-bbox="475 817 1102 913"> <thead> <tr> <th>X</th> <th>Y</th> <th>Z</th> </tr> </thead> <tbody> <tr> <td>≤2.0</td> <td>≤S</td> <td>Disregard</td> </tr> </tbody> </table> Notes: S=contact pad length Chips on the corner of terminal shall not be allowed to extend into the ITO pad or expose perimeter seal.	X	Y	Z	≤2.0	≤S	Disregard	Minor
		X	Y	Z					
		≤2.0	≤S	Disregard					
(ii) Usual surface cracks  <table border="1" data-bbox="454 1344 1125 1440"> <thead> <tr> <th>X</th> <th>Y</th> <th>Z</th> </tr> </thead> <tbody> <tr> <td>≤3.0</td> <td><Inner border line of the seal</td> <td>Disregard</td> </tr> </tbody> </table>	X	Y	Z	≤3.0	<Inner border line of the seal	Disregard	Minor		
X	Y	Z							
≤3.0	<Inner border line of the seal	Disregard							
(iii) Crack Cracks tend to break are not allowed. 	Major								
4.3.6	Parts alignment	1) Not allow IC and FPC/heat-seal lead width is more than 50% beyond lead pattern. 2) Not allow chip or solder component is off center more than 50% of the pad outline.	Minor						
4.3.7	SMT	According to the <Acceptability of electronic assemblies> IPC-A-610C class 2 standard. Component missing or function defect are Major defect, the others are Minor defect.							

■ PRECAUTIONS FOR USING LCD MODULES

Handing Precautions

(1) The display panel is made of glass and polarizer. As glass is fragile. It tends to become or chipped during handling especially on the edges. Please avoid dropping or jarring. Do not subject it to a mechanical shock by dropping it or impact.

(2) If the display panel is damaged and the liquid crystal substance leaks out, be sure not to get any in your mouth. If the substance contacts your skin or clothes, wash it off using soap and water.

(3) Do not apply excessive force to the display surface or the adjoining areas since this may cause the color tone to vary. Do not touch the display with bare hands. This will stain the display area and degraded insulation between terminals (some cosmetics are determined to the polarizer).

(4) The polarizer covering the display surface of the LCD module is soft and easily scratched. Handle this polarizer carefully. Do not touch, push or rub the exposed polarizers with anything harder than an HB pencil lead (glass, tweezers, etc.). Do not put or attach anything on the display area to avoid leaving marks on. Condensation on the surface and contact with terminals due to cold will damage, stain or dirty the polarizer. After products are tested at low temperature they must be warmed up in a container before coming is contacting with room temperature air.

(5) If the display surface becomes contaminated, breathe on the surface and gently wipe it with a soft dry cloth. If it is heavily contaminated, moisten cloth with one of the following solvents

- Isopropyl alcohol
- Ethyl alcohol

Do not scrub hard to avoid damaging the display surface.

(6) Solvents other than those above-mentioned may damage the polarizer. Especially, do not use the following.

- Water
- Ketone
- Aromatic solvents

Wipe off saliva or water drops immediately, contact with water over a long period of time may cause deformation or color fading. Avoid contacting oil and fats.

(7) Exercise care to minimize corrosion of the electrode. Corrosion of the electrodes is accelerated by water droplets, moisture condensation or a current flow in a high-humidity environment.

(8) Install the LCD Module by using the mounting holes. When mounting the LCD module make sure it is free of twisting, warping and distortion. In particular, do not forcibly pull or bend the I/O cable or the backlight cable.

(9) Do not attempt to disassemble or process the LCD module.

(10) NC terminal should be open. Do not connect anything.

(11) If the logic circuit power is off, do not apply the input signals.

(12) Electro-Static Discharge Control, Since this module uses a CMOS LSI, the same careful attention should be paid to electrostatic discharge as for an ordinary CMOS IC. To prevent destruction of the elements by static electricity, be careful to maintain an optimum work environment.

- Before remove LCM from its packing case or incorporating it into a set, be sure the module and your body have the same electric potential. Be sure to ground the body when handling the LCD modules.

- Tools required for assembling, such as soldering irons, must be properly grounded. make certain the AC power source for the soldering iron does not leak. When using an electric screwdriver to attach LCM, the screwdriver should be of ground potentiality to minimize as much as possible any transmission of electromagnetic waves produced sparks coming from the commutator of the motor.

- To reduce the amount of static electricity generated, do not conduct assembling and other work under dry conditions. To reduce the generation of static electricity be careful that the air in the work is not too dried. A relative humidity of 50%-60% is recommended. As far as possible make the electric potential of your work clothes and that of the work bench the ground potential

- The LCD module is coated with a film to protect the display surface. Exercise care when peeling off this protective film since static electricity may be generated

(13) Since LCM has been assembled and adjusted with a high degree of precision, avoid applying excessive shocks to the module or making any alterations or modifications to it.

- Do not alter, modify or change the shape of the tab on the metal frame.

- Do not make extra holes on the printed circuit board, modify its shape or change the positions of components to be attached.

- Do not damage or modify the pattern writing on the printed circuit board.

- Absolutely do not modify the zebra rubber strip (conductive rubber) or heat seal connector.

- Except for soldering the interface, do not make any alterations or modifications with a soldering iron.

- Do not drop, bend or twist LCM.

Handling precaution for LCM

LCM is easy to be damaged. Please note below and be careful for handling.

Correct handling:



As above picture, please handle with anti-static gloves around LCM edges.

Incorrect handling:



Please don't touch IC directly.

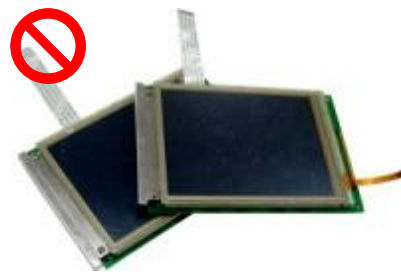

Please don't stack LCM.



Please don't hold the surface of panel.

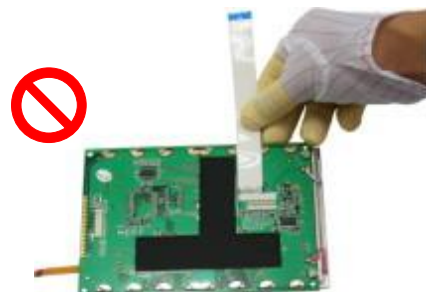

Please don't stretch interface of output, such as FPC cable.



Please don't hold the surface of IC.

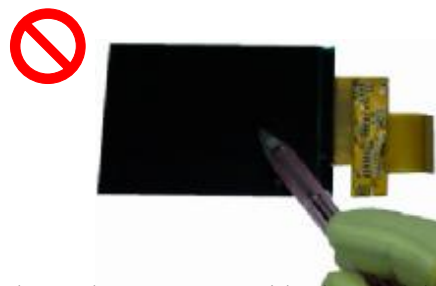

Please don't operate with sharp stick such as pens.

Storage Precautions

When storing the LCD modules, the following precaution is necessary.

- (1) Store them in a sealed polyethylene bag. If properly sealed, there is no need for the dessicant.
- (2) Store them in a dark place. Do not expose to sunlight or fluorescent light, keep the temperature between 0°C and 35°C, and keep the relative humidity between 40%RH and 60%RH.
- (3) The polarizer surface should not come in contact with any other objects. (We advise you to store them in the anti-static electricity container in which they were shipped.

Others

Liquid crystals solidify under low temperature (below the storage temperature range) leading to defective orientation or the generation of air bubbles (black or white). Air bubbles may also be generated if the module is subject to a low temperature.

If the LCD modules have been operating for a long time showing the same display patterns, the display patterns may remain on the screen as ghost images and a slight contrast irregularity may also appear. A normal operating status can be regained by suspending use for some time. It should be noted that this phenomenon does not adversely affect performance reliability.

To minimize the performance degradation of the LCD modules resulting from destruction caused by static electricity etc., exercise care to avoid holding the following sections when handling the modules.

- Exposed area of the printed circuit board.
- Terminal electrode sections.

■ USING LCD MODULES

Installing LCD Modules

The hole in the printed circuit board is used to fix LCM as shown in the picture below. Attend to the following items when installing the LCM.

- (1) Cover the surface with a transparent protective plate to protect the polarizer and LC cell.

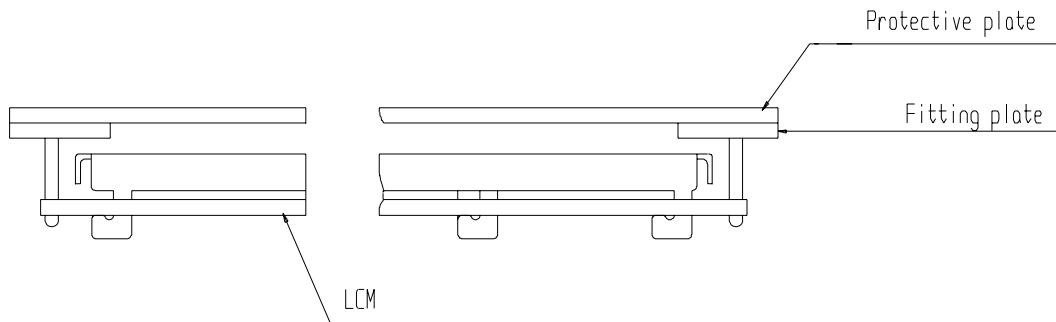

- (2) When assembling the LCM into other equipment, the spacer to the bit between the LCM and the fitting plate should have enough height to avoid causing stress to the module surface, refer to the individual specifications for measurements. The measurement tolerance should be ± 0.1 mm.

Precaution for assemble the module with BTB connector:

Please note the position of the male and female connector position, don't assemble or assemble like the method which the following picture shows

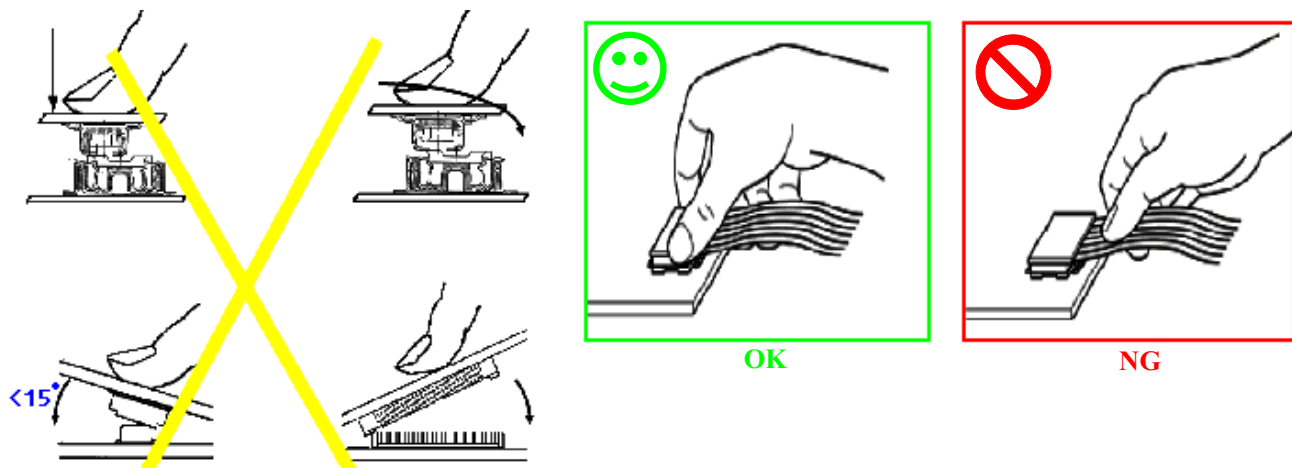

**Precaution for soldering the LCM**

	Manual soldering	Machine drag soldering	Machine press soldering
No ROHS product	290°C ~350°C. Time : 3-5S.	330°C ~350°C. Speed : 4-8 mm/s.	300°C ~330°C. Time : 3-6S. Press: 0.8~1.2Mpa
ROHS product	340°C ~370°C. Time : 3-5S.	350°C ~370°C. Time : 4-8 mm/s.	330°C ~360°C. Time : 3-6S. Press: 0.8~1.2Mpa

(1) If soldering flux is used, be sure to remove any remaining flux after finishing to soldering operation. (This does not apply in the case of a non-halogen type of flux.) It is recommended that you protect the LCD surface with a cover during soldering to prevent any damage due to flux spatters.

(2) When soldering the electroluminescent panel and PC board, the panel and board should not be detached more than three times. This maximum number is determined by the temperature and time conditions mentioned above, though there may be some variance depending on the temperature of the soldering iron.

(3) When remove the electroluminescent panel from the PC board, be sure the solder has completely melted, the soldered pad on the PC board could be damaged.

Precautions for Operation

(1) Viewing angle varies with the change of liquid crystal driving voltage (VLCD). Adjust VLCD to show the best contrast.

(2) It is an indispensable condition to drive LCD's within the specified voltage limit since the higher voltage than the limit cause the shorter LCD life. An electrochemical reaction due to direct current causes LCD's undesirable deterioration, so that the use of direct current drive should be avoided.

(3) Response time will be extremely delayed at lower temperature than the operating temperature range and on the other hand at higher temperature LCD's show dark color in them. However those phenomena do not mean malfunction or out of order with LCD's, Which will come back in the specified operating temperature.

(4) If the display area is pushed hard during operation, the display will become abnormal. However, it will return to normal if it is turned off and then back on.

(5) A slight dew depositing on terminals is a cause for electro-chemical reaction resulting in terminal open circuit. Usage under the maximum operating temperature, 50%RH or less is required.

(6) Input logic voltage before apply analog high voltage such as LCD driving voltage when power on. Remove analog high voltage before logic voltage when power off the module. Input each signal after the positive/negative voltage becomes stable.

(7) Please keep the temperature within specified range for use and storage. Polarization degradation, bubble generation or polarizer peel-off may occur with high temperature and high humidity.

Safety

(1) It is recommended to crush damaged or unnecessary LCDs into pieces and wash them off with solvents such as acetone and ethanol, which should later be burned.

(2) If any liquid leaks out of a damaged glass cell and comes in contact with the hands, wash off thoroughly with soap and water.

Limited Warranty

Unless agreed between Multi-Inno and customer, Multi-Inno will replace or repair any of its LCD modules which are found to be functionally defective when inspected in accordance with Multi-Inno LCD acceptance standards (copies available upon request) for a period of one year from date of production. Cosmetic/visual defects must be returned to Multi-Inno within 90 days of shipment. Confirmation of such date shall be based on data code on product. The warranty liability of Multi-Inno limited to repair and/or replacement on the terms set forth above. Multi-Inno will not be responsible for any subsequent or consequential events.

Return LCM under warranty

No warranty can be granted if the precautions stated above have been disregarded. The typical examples of violations are :

- Broken LCD glass.
- PCB eyelet is damaged or modified.
- PCB conductors damaged.
- Circuit modified in any way, including addition of components.
- PCB tampered with by grinding, engraving or painting varnish.
- Soldering to or modifying the bezel in any manner.



Module repairs will be invoiced to the customer upon mutual agreement. Modules must be returned with sufficient description of the failures or defects. Any connectors or cable installed by the customer must be removed completely without damaging the PCB eyelet, conductors and terminals.

■ PRIOR CONSULT MATTER

- 1.①For Multi-Inno standard products, we keep the right to change material, process ... for improving the product property without notice on our customer.
②For OEM products, if any change needed which may affect the product property, we will consult with our customer in advance.
2. If you have special requirement about reliability condition, please let us know before you start the test on our samples.