

SPECIFICATION FOR APPROVAL

REF. :

PROD. NAME	Shielded SMD Power Inductor	ABC'S DWG NO.	SU5011□□□□L□-□□□		
		REV.	20151214-D	PAGE	1

I . Configuration and dimensions :

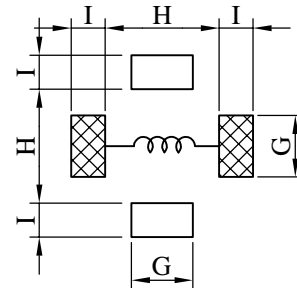
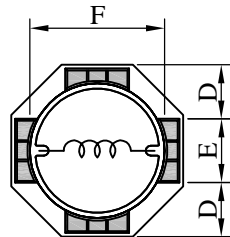
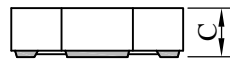
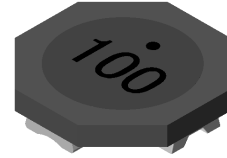
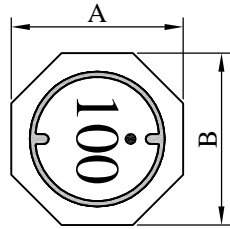

(PCB Pattern)

Unit : m/m

A	B	C	D	E	F	G	H	I
5.20 ±0.20	5.20 ±0.20	1.10 ±0.10	1.70 typ.	1.80 typ.	3.90 typ.	2.00 ref.	3.70 ref.	1.10 ref.

II . Description :

- a . Ferrite drum core construction.
- b . Magnetically shielded.
- c . Enamelled copper wire : F 、 H class
- d . Product weight : 0.09 g (ref.)
- e . Moisture sensitivity Level 1
- f . Products comply with RoHS' requirements
- g . Halogen free available

III . General specification :

- a . Storage temp. : -40°C ----+125°C
- b . Operating temp. : -40°C ----+125°C
(Temp. rise included.)
- c . Resistance to solder heat : 260°C .10 secs.

Peak Temp : 260°C max.
Max. Peak Temp - 5°C : 30sec max.
Max time above 217°C : 60sec~150sec max.

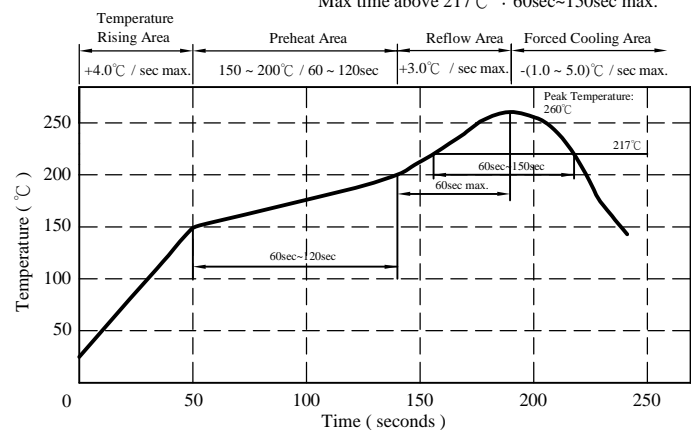

AR-001C

SPECIFICATION FOR APPROVAL

REF. :

PROD. NAME	Shielded SMD Power Inductor	ABC'S DWG NO.	SU5011□□□□L□-□□□		
		REV.	20151214-D	PAGE	2

IV . Electrical characteristics :

DWG No.	Inductance (μ H)	Q ref.	SRF (MHz) typ.	RDC (m Ω)		Irms (mA) max.	Isat (mA) max.
				typ.	max.		
SU50111R5YL□-□□□	1.5 \pm 30 %	8	195	32	42	1800	1500
SU50112R5YL□-□□□	2.5 \pm 30 %	8	125	52	68	1300	1100
SU50113R3YL□-□□□	3.3 \pm 30 %	8	110	66	85	1150	940
SU50114R7YL□-□□□	4.7 \pm 30 %	8	85	95	120	1000	820
SU50116R8YL□-□□□	6.8 \pm 30 %	8	70	130	170	820	680
SU5011100YL□-□□□	10.0 \pm 30 %	12	50	170	220	700	580
SU5011150YL□-□□□	15.0 \pm 30 %	12	42	250	320	600	480
SU5011220YL□-□□□	22.0 \pm 30 %	14	38	380	500	500	400
SU5011330YL□-□□□	33.0 \pm 30 %	14	30	550	700	380	300
SU5011470YL□-□□□	47.0 \pm 30 %	16	25	800	1050	320	260
SU5011680YL□-□□□	68.0 \pm 30 %	14	20	1240	1600	260	220
SU5011101YL□-□□□	100.0 \pm 30 %	30	15	1600	2000	200	180

- 1) . □ : Packaging information : □ Code
- 2) . "- □□□":Reference code
- 3) . Electrical specifications at 25°C
- 4) . Irms base on Temp. rise 25°C max.
- 5) . Isat base on Δ L / L0A=35% max.
- 6) . Q Test Freq. : 1R5~100--7.96MHz , 150~680--2.52MHz , 101--0.796MHz
- 7) . Inductance Test Freq. : 100kHz / 0.1V

SPECIFICATION FOR APPROVAL

REF. :

PROD. NAME	Shielded SMD Power Inductor	ABC'S DWG NO.	SU5011□□□□L□-□□□		
		REV.	20151214-D	PAGE	3

V . Curve :

SU50111R5YL□

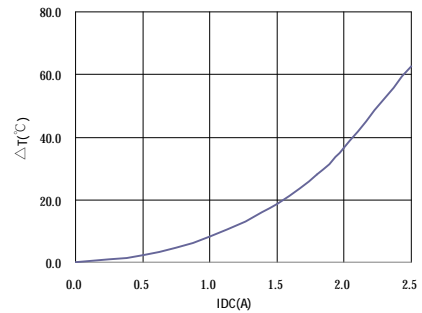
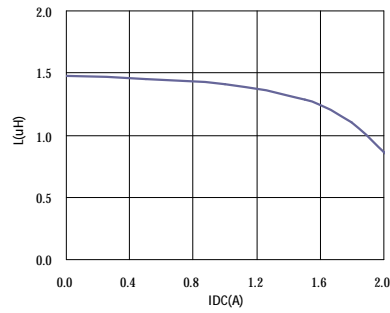

SU50116R8YL□

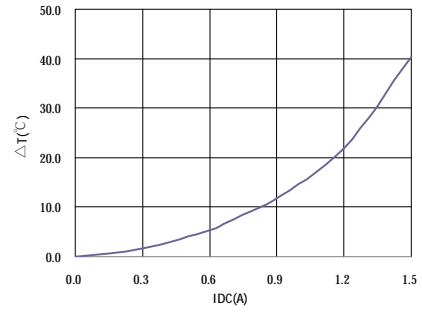
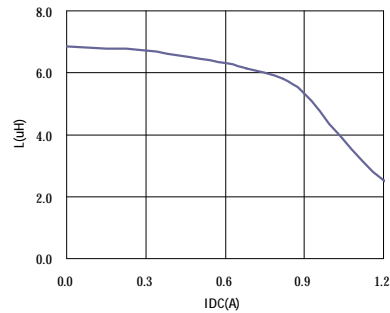

SU5011220YL□

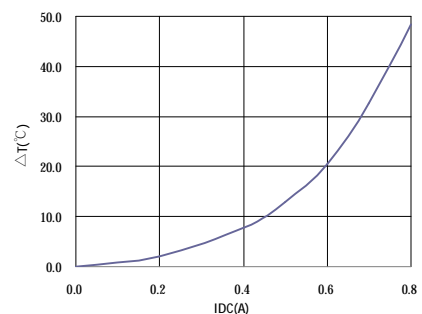
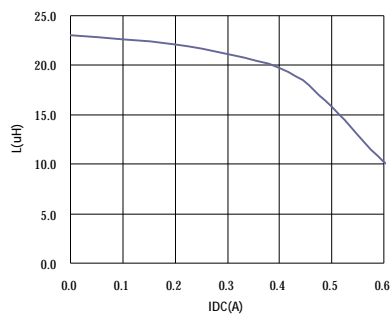

SU5011101YL□

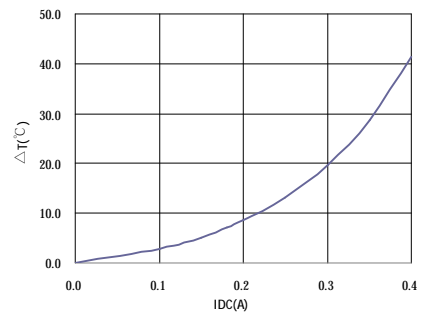
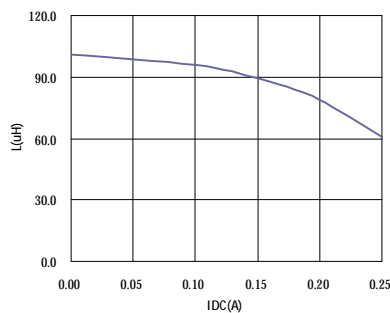

AR-001C

SPECIFICATION FOR APPROVAL

REF. :

PROD. NAME	Shielded SMD Power Inductor	ABC'S DWG NO.	SU5011□□□□L□-□□□		
		REV.	20151214-D	PAGE	4

VI . Packaging information :

(1) Configuration

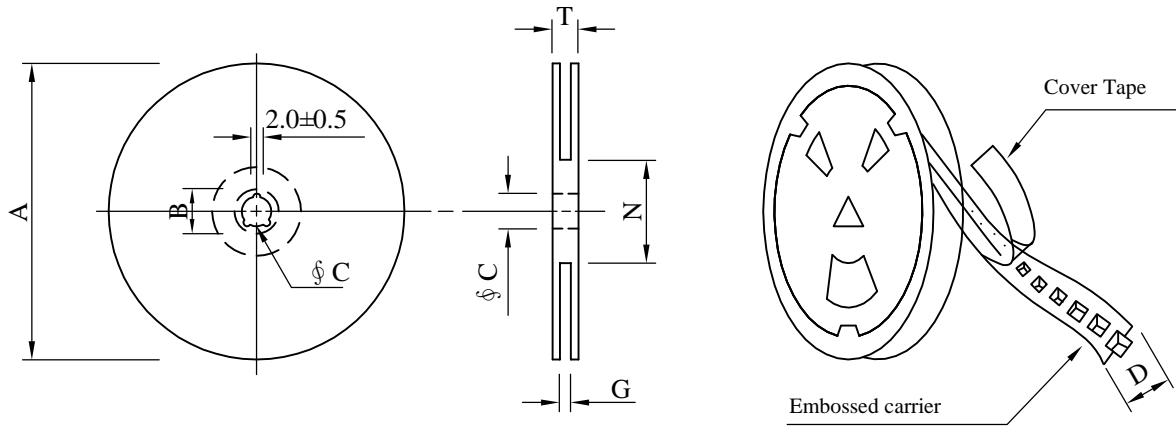

※Carrier tape width : D

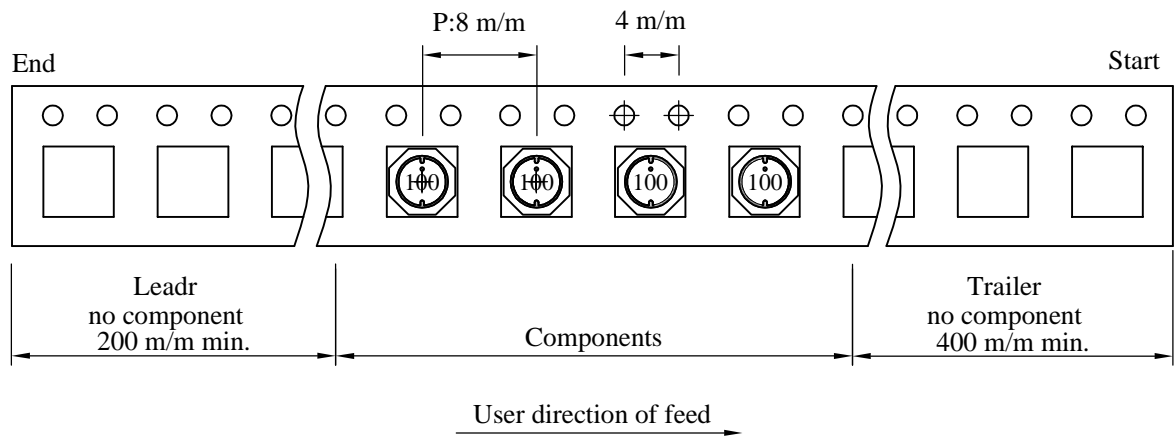

(2) Dimensions

Unit:m/m

Style	A	B	C	D	G	N	T
07 - 12	178	21±0.8	13	12	14 ⁺⁰	50 ⁻⁰	16.5

(3) Q'TY & G.W. Per package

Code	Inner : Reel			Outer : Carton		
	Q'TY (pcs)	G.W. (gw)	Style	Q'TY (pcs)	G.W. (Kg)	Size (cm)
B	1,500	270	07 - 12	60,000	12.1	42 x 41 x 24

AR-001C

SPECIFICATION FOR APPROVAL

REF. :

PROD. NAME	Shielded SMD Power Inductor	ABC'S DWG NO.	SU5011□□□□L□-□□□		
		REV.	20151214-D	PAGE	5

VII . Reliability test :

Item	Reference documents	Test Condition	Test Specification
1.High Temperature Exposure	MIL-STD-202 Method 108	1.Temperature: 125±2℃ 2.Time:96±2 hours.	1.No mechanical or electrical damage. 2.Inductance shall not change more than ±20%.
2.Temperature Cycling	JESD22-A 104	1.Temperature: -40℃ ~ +125℃ 2.Number of cycle:100 cycle 3.Dwell time:30 minutes	1.No mechanical or electrical damage. 2.Inductance shall not change more than ±20%.
3.Biased Humidity Test	MIL-STD-202 Method 103	1.Temperature : 85±2 ℃ 2.Humidity: 85% RH. 3.Time:96±2 Hours	1.No mechanical or electrical damage. 2.Inductance shall not change more than ±20%.
4.Operational Life	JESD22-A 108	1.Temperature: 125℃ (Temp. rise included) 2.Time:96±2 hours. 3.Rated current	1.No mechanical or electrical damage. 2.Inductance shall not change more than ±20%.
5.External Visual	JESD22-B 101 & MIL-STD-883 Method 2009	Inspect product constructions, marking and workmanship.	1.No pollution on the surface of products. 2.Clear marking. 3.No crack.
6.Physical Dimensions	JESD22-B 100	Verify physical dimensions to the applicable product detail specification.	Per product specification standard
7.Resistance to solvents	MIL-STD-202 Method 215	Immerse into solvent for 3±0.5 minutes & brush 10 times for 3 cycles.	1.No body change in apperance. 2.No marking blurred. 3.Inductance shall not change more than ±20%.
8.Vibration Test	MIL-STD-202 Method 204	1.Frequency and Amplitued : 10-2000-10 Hz, 1.5 mm. 2.Direction:X, Y, Z 3.Test duration:2 hours for each direction, 6 hours in total.	1.No mechanical or electrical damage. 2.Inductance shall not change more than ±20%.
9.Resistance To Soldering Heat Test	MIL-STD-202 Method 210 & J-STD020D.1	1.Highest temperature : 260±5℃. 2.Time (temp. ≥ 217℃) : 60~150 Second. 3.IR reflow times : 3 times.	1.No mechanical or electrical damage. 2.Inductance shall not change more than ±20%.
10.Saturation Current	JIS C 6436 & User SPEC.	1.Applied rated current for 5 second. 2.Saturation current	Inductance shall not drop more than 35% max.
11.Over load	JIS C 6436 & User SPEC.	1.Applied one and half rated current for a period of 5 minutes. 2.Rated current	No electrical or mechanical damage
12.Temperature Rise Current	JIS C 6436 & User SPEC.	1.Applied rated current for 10 minutes. 2.Temperature measure by digital surface thermometer. 3.Irms current	Surface temperature rise is less than 25℃ max.
13.Solderability Test	J-STD-002 & JESD22-B 102	1.Baking in pre-testing : 150±5℃ / 16Hours±30 min. 2.Peak temperature : 240±5℃ 3.Time (temp. ≥ 217℃) : 60~150 second. 4.IR reflow times : 1 times.	More than 95% soldering coverage min on terminations.
14.Electrical Characteriazation	MIL-STD-202 Method 304 & User SPEC.	1.Operating temperature : -40℃~125℃ 2.Room temperature : 25℃.	1.No mechanical or electrical damage. 2.Inductance shall not change more than ±20%.
15.Drop	CNS-C6354 & GB/T 2423.8	1.Products shall be mounted on SPEC. PCB and dropped down from a height of 1m 2.Drop total time : 6 time (Every side of sample drop 2 time)	1. Adhesion on PCB shall be enough. 2. Product appearance shall not break. 3. No electrical damage.
16.Terminal Strength Test	IEC 60068-2-21	1.Apply push force to samples mounted on PCB. 2.Force of 1.8 kg for 60±1 seconds.	After test, inductors shall be no mechanical damage.

AR-001C