

6

5

4

3

2

1

APPROVED: \_\_\_\_\_

DATE: \_\_\_\_\_ TITLE: \_\_\_\_\_

Rev	AWO #	Description	Date	Appr
-----	-------	-------------	------	------

SEE SHT 1 OF 2 FOR REVISION

### SHORT SHELL

### LONG SHELL

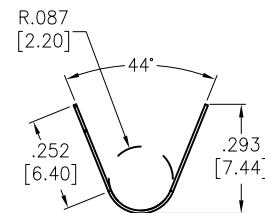
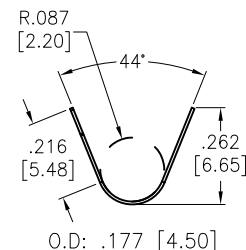
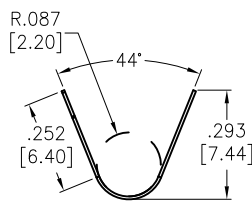
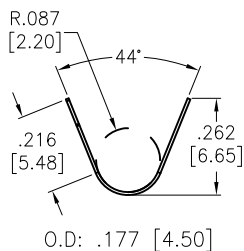
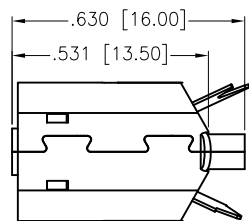
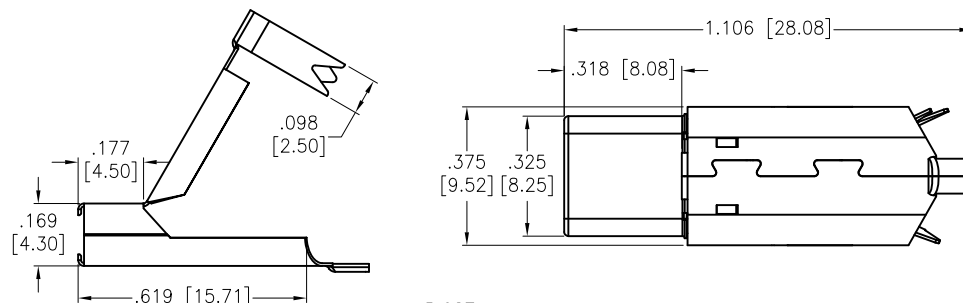
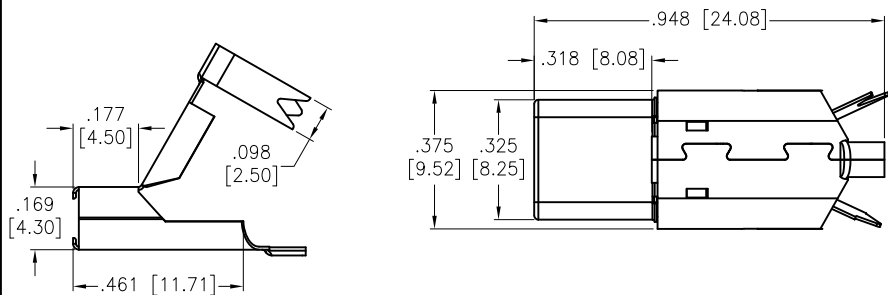

USB-C31-PLUG-B-S1-BK-PCB

O.D: .197 [5.00]

USB-C31-PLUG-B-S2-BK-PCB

USB-C31-PLUG-B-L1-BK-PCB

O.D: .197 [5.00]

USB-C31-PLUG-B-L2-BK-PCB

UNLESS OTHERWISE SPECIFIED  
 ALL DIMENSIONS ARE INCHES [MM]  
 TOLERANCES: EXCEPT AS NOTED  
 INCHES HOLES

.X	± .10	∅X	± .10
.XX	± .020	∅XX	± .015
.XXX	± .015	∅XXX	± .010

## ADAM TECH

909 Rahway Avenue, Union, NJ 07083  
Phone: 908-687-5000 Fax: 908-687-5710

APPROVALS		DATE
DRAWN	HR	5/6/16
CHECKED	MW	5/6/16
APPROVED		

TITLE		
UNIVERSAL SERIAL BUS, TYPE C, MALE PLUG, STRADDLE MOUNT, BLACK INSULATOR, W/ PCB		
SIZE	PART NO.	REV.
X	USB-C31-PLUG-B-XX-BK-PCB	-
REF:	S00097C	SCALE: NTS
		SHEET 2 OF 2

6

5

4

3

2

1